

**Contact element, 2N/O, front mount, spring clamp connection**

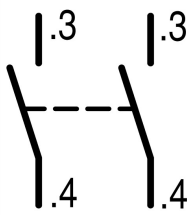

**Part no.** M22-CK20  
**Catalog No.** 107898  
**Eaton Catalog No.** M22-CK20Q  
**EL-Nummer (Norway)** 4355494

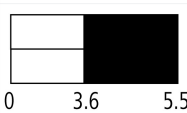

**Delivery program**

Product range		Accessories
Standard/Approval		UL/CSA, IEC
Construction size		NZM1/2/3/4
Single unit/Complete unit		Element
Basic function accessories		Contact elements
Approval		
Connection technique		Cage Clamp
Fixing		Front fixing
Description		When using emergency switching off actuators M22-PV... max. 2 contact elements = 4 NC / N/O contacts Cage Clamp is a registered trademark of Wago Kontakttechnik GmbH/Minden, Germany
<b>Contacts</b>		
N/O = Normally open		2 N/O
<b>Actuator travel and actuation force as per DIN EN 60947-5-1, K.5.4.1</b>		
Minimum force for positive opening	N	0
Contact sequence		
Contact travel diagram, stroke in connection with front element		
Degree of Protection		IP20
Connection to SmartWire-DT		no
Connection type		Double contact
Description of HIA trip-indicating auxiliary contact		General trip indication '+', when tripped by shunt release, overload release, short-circuit release or by the residual-current release due to residual-current. Can be used with NZM1, 2, 3 circuit-breaker: a trip-indicating auxiliary contact can be clipped into the circuit-breaker. Can be used with NZM4 circuit-breaker: up to two standard auxiliary contacts can be clipped into the circuit-breaker. Any combinations of the auxiliary contact types are possible. Not in combination with switch-disconnector PN...

			Marking on switch: HIA Labeling in FI-Block: HIAFI. If the trip-indicating auxiliary switch in the fault current block is used, the NC contacts operates as a N/O contact and the NC contact operates as an N/O contact.
Description standard auxiliary contact HIN			Switching with the main contacts Used for indicating and interlocking tasks. Can be used with NZM1 circuit-breaker: a standard auxiliary contact can be clipped into the circuit-breaker. Can be used with NZM2 size circuit-breaker: a standard auxiliary contact can be clipped into the circuit-breaker. Can be used with NZM3, 4 circuit-breaker: up to three standard auxiliary contacts can be clipped into the circuit-breaker. Any combinations of the auxiliary contact types are possible. Marking on switch: HIN. On combination with remote operator NZM-XR... the right mounting location of standard auxiliary contact HIN can be fitted only with individual contacts.
For use with			NZM1(-4), 2(-4), 3(-4), 4(-4) PN1(-4), 2(-4), 3(-4) N(S)1(-4), 2(-4), 3(-4), 4(-4)

## Technical data

### General

Standards			IEC 60947-5-1
Operating frequency	Operations/h		 3600
Actuating force	n		 10
Degree of Protection			IP20
Climatic proofing			Damp heat, constant, to IEC 60068-2-78 Damp heat, cyclic, to IEC 60068-2-30
Ambient temperature			
Open	°C		-25 - +70
Terminal capacities	mm <sup>2</sup>		
Solid	mm <sup>2</sup>		0.5 - 1.5
Stranded	mm <sup>2</sup>		0.5 - 1.5
Flexible with ferrule	mm <sup>2</sup>		0.5 - 1.5

### Contacts

Rated impulse withstand voltage	$U_{imp}$	V AC	4000
Rated insulation voltage	$U_i$	V	250
Overvoltage category/pollution degree			III/3
Control circuit reliability			
at 24 V DC/5 mA	$H_F$	Fault probability	< 10 <sup>-7</sup> (i.e. 1 failure to 10 <sup>7</sup> operations)
at 5 V DC/1 mA	$H_F$	Fault probability	< 5 x 10 <sup>-6</sup> (i.e. 1 failure to 5 x 10 <sup>6</sup> operations)
Max. short-circuit protective device			
Fuseless		Type	PKZM0-10/FAZ-B6/1
Fuse	gG/gL	A	10

### Switching capacity

Rated operational current	$I_e$	A	
AC-15			
115 V	$I_e$	A	4
220 V 230 V 240 V	$I_e$	A	4
DC-13			
24 V	$I_e$	A	3
42 V	$I_e$	A	1
60 V	$I_e$	A	0.8
110 V	$I_e$	A	0.5
220 V	$I_e$	A	0.3

### Auxiliary contacts

Rated operational voltage	$U_e$	V	
Rated operational voltage	$U_e$	V AC	230
Rated operational voltage, max.	$U_e$	V DC	220
Conventional thermal current	$I_{th} = I_e$	CSA	4

Rated operational current	$I_e$	A					
<b>Different rated operational currents</b> when used as auxiliary contact for NZM circuit-breaker					M22- (C)K10(01)	M22- CK11(02) (20)	XHIV
				bei AC = 50/60 Hz			
		Bemessungsbetriebsstrom					
		AC-15	$I_e$	A	4	4	4
		15 V					
		230 V	$I_e$	A	4	4	4
		400 V	$I_e$	A	2	-	2
		500 V	$I_e$	A	1	-	1
		DC-14	$I_e$	A	3	3	3
		42 V	$I_e$	A	1.7	1	1.5
		60 V	$I_e$	A	1.2	0.8	0.8
		110 V	$I_e$	A	0.6	0.5	0.5
	220 V	$I_e$	A	0.3	0.2	0.2	
Short-circuit protection							
max. fuse		A gG/gL	10				
Max. miniature circuit-breaker		A	FAZ-B6/B1				
Operating times							
					Early-make time of the HIV compared to the main contacts during with make and break switching.		
					(switch times with manual operation):		
					NZM1, PN1, N(S)1: ca. 20 ms		
					NZM2, PN2, N(S)2: ca. 20 ms		
					NZM3, PN3, N(S)3: ca. 20 ms		
					NZM4, N(S)4: approx. 90 ms, the HIV switch early <b>Offswitching not</b> forward.		
Terminal capacities		mm <sup>2</sup>					
Solid or flexible conductor, with ferrule		mm <sup>2</sup>	1 x (0,5 - 1,5) 2 x (0,5 - 0,75)				
		AWG	1 x (20 - 18) 2 x (20 - 18)				
Other technical data (sheet catalogue)			Maximum equipment and position of the internal accessories				

## Design verification as per IEC/EN 61439

Technical data for design verification			
Rated operational current for specified heat dissipation	$I_n$	A	4
Heat dissipation per pole, current-dependent	$P_{vid}$	W	0.05
Equipment heat dissipation, current-dependent	$P_{vid}$	W	0
Static heat dissipation, non-current-dependent	$P_{vs}$	W	0
Heat dissipation capacity	$P_{diss}$	W	0
Operating ambient temperature min.		°C	-25
Operating ambient temperature max.		°C	70
IEC/EN 61439 design verification			
10.2 Strength of materials and parts			
10.2.2 Corrosion resistance			Meets the product standard's requirements.
10.2.3.1 Verification of thermal stability of enclosures			Meets the product standard's requirements.
10.2.3.2 Verification of resistance of insulating materials to normal heat			Meets the product standard's requirements.
10.2.3.3 Verification of resistance of insulating materials to abnormal heat and fire due to internal electric effects			Meets the product standard's requirements.
10.2.4 Resistance to ultra-violet (UV) radiation			Meets the product standard's requirements.
10.2.5 Lifting			Does not apply, since the entire switchgear needs to be evaluated.
10.2.6 Mechanical impact			Does not apply, since the entire switchgear needs to be evaluated.
10.2.7 Inscriptions			Meets the product standard's requirements.
10.3 Degree of protection of ASSEMBLIES			Does not apply, since the entire switchgear needs to be evaluated.
10.4 Clearances and creepage distances			Meets the product standard's requirements.

10.5 Protection against electric shock		Does not apply, since the entire switchgear needs to be evaluated.
10.6 Incorporation of switching devices and components		Does not apply, since the entire switchgear needs to be evaluated.
10.7 Internal electrical circuits and connections		Is the panel builder's responsibility.
10.8 Connections for external conductors		Is the panel builder's responsibility.
10.9 Insulation properties		
10.9.2 Power-frequency electric strength		Is the panel builder's responsibility.
10.9.3 Impulse withstand voltage		Is the panel builder's responsibility.
10.9.4 Testing of enclosures made of insulating material		Is the panel builder's responsibility.
10.10 Temperature rise		The panel builder is responsible for the temperature rise calculation. Eaton will provide heat dissipation data for the devices.
10.11 Short-circuit rating		Is the panel builder's responsibility. The specifications for the switchgear must be observed.
10.12 Electromagnetic compatibility		Is the panel builder's responsibility. The specifications for the switchgear must be observed.
10.13 Mechanical function		The device meets the requirements, provided the information in the instruction leaflet (IL) is observed.

## Technical data ETIM 6.0

Low-voltage industrial components (EG000017) / Auxiliary contact block (EC000041)

Electric engineering, automation, process control engineering / Low-voltage switch technology / Component for low-voltage switching technology / Auxiliary switch block (ecl@ss8.1-27-37-13-02 [AKN342010])

Number of contacts as change-over contact		0
Number of contacts as normally open contact		2
Number of contacts as normally closed contact		0
Rated operation current I <sub>e</sub> at AC-15, 230 V	A	6
Type of electric connection		Spring clamp connection
Model		Top mounting and integrable
Mounting method		Front fastening

## Approvals

Product Standards		IEC/EN 60947-5; UL 508; CSA-C22.2 No. 14-05; CSA-C22.2 No. 94-91; CE marking
UL File No.		E29184
UL Category Control No.		NKCR
CSA File No.		012528
CSA Class No.		3211-03
North America Certification		UL listed, CSA certified
Degree of Protection		UL/CSA Type: -

## Dimensions

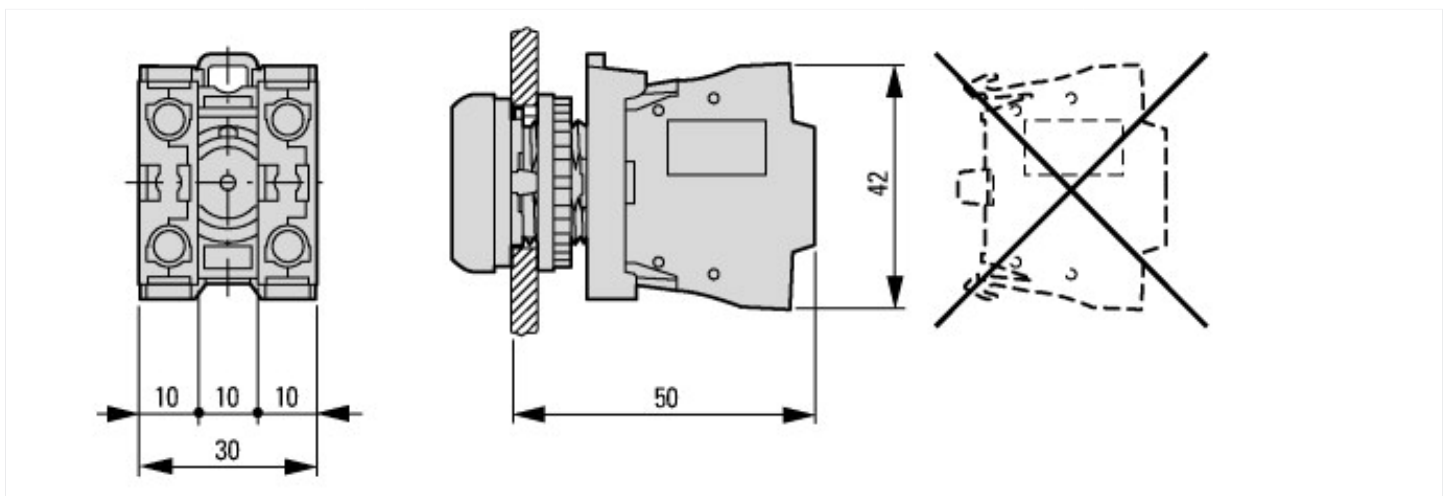

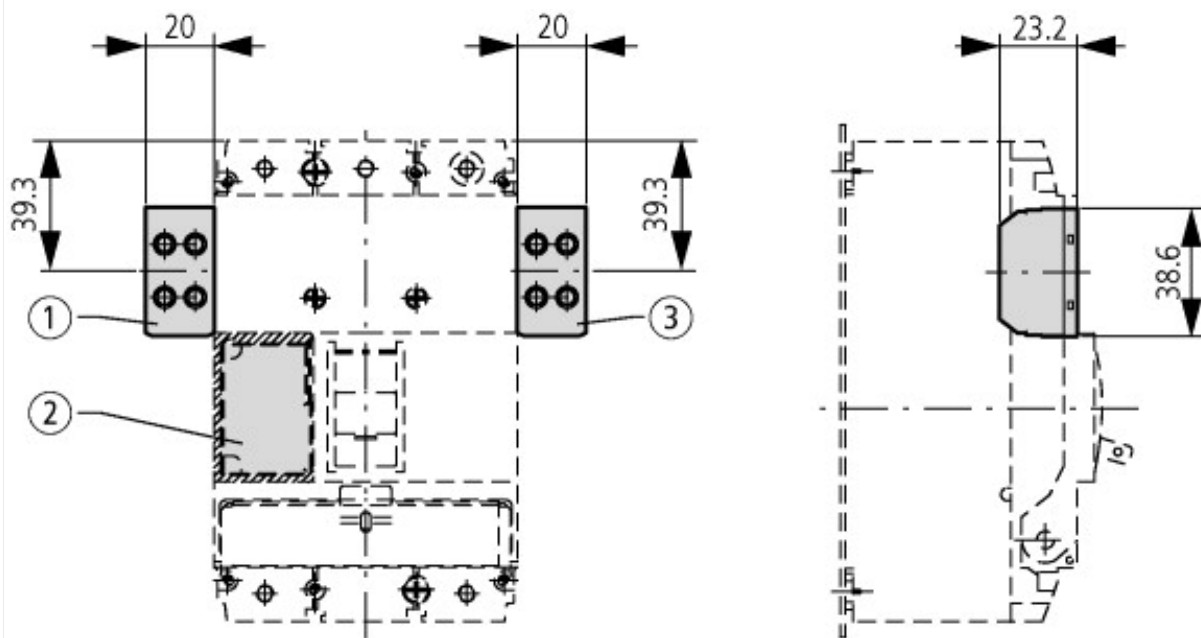

①

NZM1-XA(HIV)  
 NZM1-XA(HIV)(20)  
 NZM1-XHIV

②

NZM1-XA(HIV)(L)  
 NZM1-XU(V)(HIV)(L)(20)  
 NZM1-XHIV(L)

③

NZM1-XHIVR

Pushbutton with M22-(C)K...

Pushbutton with M22-(C) LED... + M22-XLED...

## Additional product information (links)

### IL04716002Z (AWA1160-1745) RMQ-Titan System

IL04716002Z (AWA1160-1745) RMQ-Titan System

[ftp://ftp.moeller.net/DOCUMENTATION/AWA\\_INSTRUCTIONS/IL04716002Z2017\\_01.pdf](ftp://ftp.moeller.net/DOCUMENTATION/AWA_INSTRUCTIONS/IL04716002Z2017_01.pdf)

DGUV Test Mark Customer Information

[http://www.dguv.de/medien/dguv-test-medien/\\_pdf\\_zip\\_doc\\_ppt/agb-und-pzo/dguv\\_test\\_zeichen\\_infoblatt\\_kunden.pdf](http://www.dguv.de/medien/dguv-test-medien/_pdf_zip_doc_ppt/agb-und-pzo/dguv_test_zeichen_infoblatt_kunden.pdf)

Maximum equipment and position of the internal accessories

<http://ecat.moeller.net/flip-cat/?edition=HPLEN&startpage=17.178>