

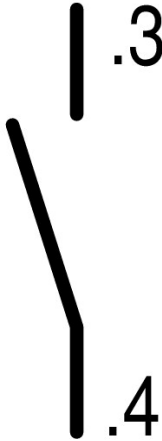



**Contact element, 1N/O, base fixing, 6. contact, screw connection**

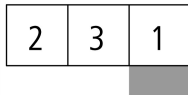

**Part no.** M22-KC10  
**Catalog No.** 216380  
**Eaton Catalog No.** M22-KC10Q  
**EL-Nummer (Norway)** 4355365

**Delivery program**

Product range		Accessories
Single unit/Complete unit		Element
Basic function accessories		Contact elements
Approval		
Connection technique		Screw terminals
Fixing		Base fixing
<b>Contacts</b>		
N/O = Normally open		1 N/O
<b>Actuator travel and actuation force as per DIN EN 60947-5-1, K.5.4.1</b>		
Minimum force for positive opening	N	0
Contact sequence		
Contact travel diagram, stroke in connection with front element		
Configuration		
Degree of Protection		IP20
Connection to SmartWire-DT		no
Connection type		Single contact
<b>Notes</b>		
Up to 3 off per enclosure base		

## Technical data

### General

Standards			IEC 60947-5-1
Lifespan, mechanical	Operations	$\times 10^6$	> 5
Operating frequency	Operations/h		 3600
Actuating force	n		 5
Operating torque (screw terminals)	Nm		 0.8
Degree of Protection			IP20
Climatic proofing			Damp heat, constant, to IEC 60068-2-78 Damp heat, cyclic, to IEC 60068-2-30
Ambient temperature			
Open	°C		-25 - +70
Mechanical shock resistance to IEC 60068-2-27 Shock duration 11 ms, half-sinusoidal	g		> 30
Terminal capacities	mm <sup>2</sup>		
Solid	mm <sup>2</sup>		0.75 - 2.5
Stranded	mm <sup>2</sup>		0.5 - 2.5
Flexible with ferrule	mm <sup>2</sup>		0.5 - 1.5

### Contacts

Rated impulse withstand voltage	$U_{imp}$	V AC	6000
Rated insulation voltage	$U_i$	V	500
Overvoltage category/pollution degree			III/3
Control circuit reliability			
at 24 V DC/5 mA	$H_F$	Fault probability	$< 10^{-7}$ (i.e. 1 failure to $10^7$ operations)
at 5 V DC/1 mA	$H_F$	Fault probability	$< 5 \times 10^{-6}$ (i.e. 1 failure in $5 \times 10^6$ operations)
Max. short-circuit protective device			
Fuseless		Type	PKZM0-10/FAZ-B6/1
Fuse	gG/gL	A	10

### Switching capacity

Rated operational current	$I_e$	A	
AC-15			
115 V	$I_e$	A	6
220 V 230 V 240 V	$I_e$	A	6
380 V 400 V 415 V	$I_e$	A	4
500 V	$I_e$	A	2
DC-13			
24 V	$I_e$	A	3
42 V	$I_e$	A	1.7
60 V	$I_e$	A	1.2
110 V	$I_e$	A	0.6
220 V	$I_e$	A	0.3
Lifespan, electrical			
AC-15			
230 V/0.5 A	Operations	$\times 10^6$	1.6
230 V/1.0 A	Operations	$\times 10^6$	1
230 V/3.0 A	Operations	$\times 10^6$	0.7
DV-13			
12 V/2.8 A	Operations	$\times 10^6$	1.2

## Design verification as per IEC/EN 61439

Technical data for design verification			
Rated operational current for specified heat dissipation	$I_n$	A	6

Heat dissipation per pole, current-dependent	P <sub>vid</sub>	W	0.11
Equipment heat dissipation, current-dependent	P <sub>vid</sub>	W	0
Static heat dissipation, non-current-dependent	P <sub>vs</sub>	W	0
Heat dissipation capacity	P <sub>diss</sub>	W	0
Operating ambient temperature min.		°C	-25
Operating ambient temperature max.		°C	70
IEC/EN 61439 design verification			
10.2 Strength of materials and parts			
10.2.2 Corrosion resistance			Meets the product standard's requirements.
10.2.3.1 Verification of thermal stability of enclosures			Meets the product standard's requirements.
10.2.3.2 Verification of resistance of insulating materials to normal heat			Meets the product standard's requirements.
10.2.3.3 Verification of resistance of insulating materials to abnormal heat and fire due to internal electric effects			Meets the product standard's requirements.
10.2.4 Resistance to ultra-violet (UV) radiation			Meets the product standard's requirements.
10.2.5 Lifting			Does not apply, since the entire switchgear needs to be evaluated.
10.2.6 Mechanical impact			Does not apply, since the entire switchgear needs to be evaluated.
10.2.7 Inscriptions			Meets the product standard's requirements.
10.3 Degree of protection of ASSEMBLIES			Does not apply, since the entire switchgear needs to be evaluated.
10.4 Clearances and creepage distances			Meets the product standard's requirements.
10.5 Protection against electric shock			Does not apply, since the entire switchgear needs to be evaluated.
10.6 Incorporation of switching devices and components			Does not apply, since the entire switchgear needs to be evaluated.
10.7 Internal electrical circuits and connections			Is the panel builder's responsibility.
10.8 Connections for external conductors			Is the panel builder's responsibility.
10.9 Insulation properties			
10.9.2 Power-frequency electric strength			Is the panel builder's responsibility.
10.9.3 Impulse withstand voltage			Is the panel builder's responsibility.
10.9.4 Testing of enclosures made of insulating material			Is the panel builder's responsibility.
10.10 Temperature rise			The panel builder is responsible for the temperature rise calculation. Eaton will provide heat dissipation data for the devices.
10.11 Short-circuit rating			Is the panel builder's responsibility. The specifications for the switchgear must be observed.
10.12 Electromagnetic compatibility			Is the panel builder's responsibility. The specifications for the switchgear must be observed.
10.13 Mechanical function			The device meets the requirements, provided the information in the instruction leaflet (IL) is observed.

## Technical data ETIM 6.0

Low-voltage industrial components (EG000017) / Auxiliary contact block (EC000041)			
Electric engineering, automation, process control engineering / Low-voltage switch technology / Component for low-voltage switching technology / Auxiliary switch block (ecl@ss8.1-27-37-13-02 [AKN342010])			
Number of contacts as change-over contact			0
Number of contacts as normally open contact			1
Number of contacts as normally closed contact			0
Rated operation current I <sub>e</sub> at AC-15, 230 V		A	6
Type of electric connection			Screw connection
Model			Top mounting
Mounting method			Floor fastening

## Approvals

Product Standards			IEC/EN 60947-5; UL 508; CSA-C22.2 No. 14-05; CSA-C22.2 No. 94-91; CE marking
UL File No.			E29184
UL Category Control No.			NKCR
CSA File No.			012528
CSA Class No.			3211-03
North America Certification			UL listed, CSA certified
Degree of Protection			UL/CSA Type: -

## Dimensions

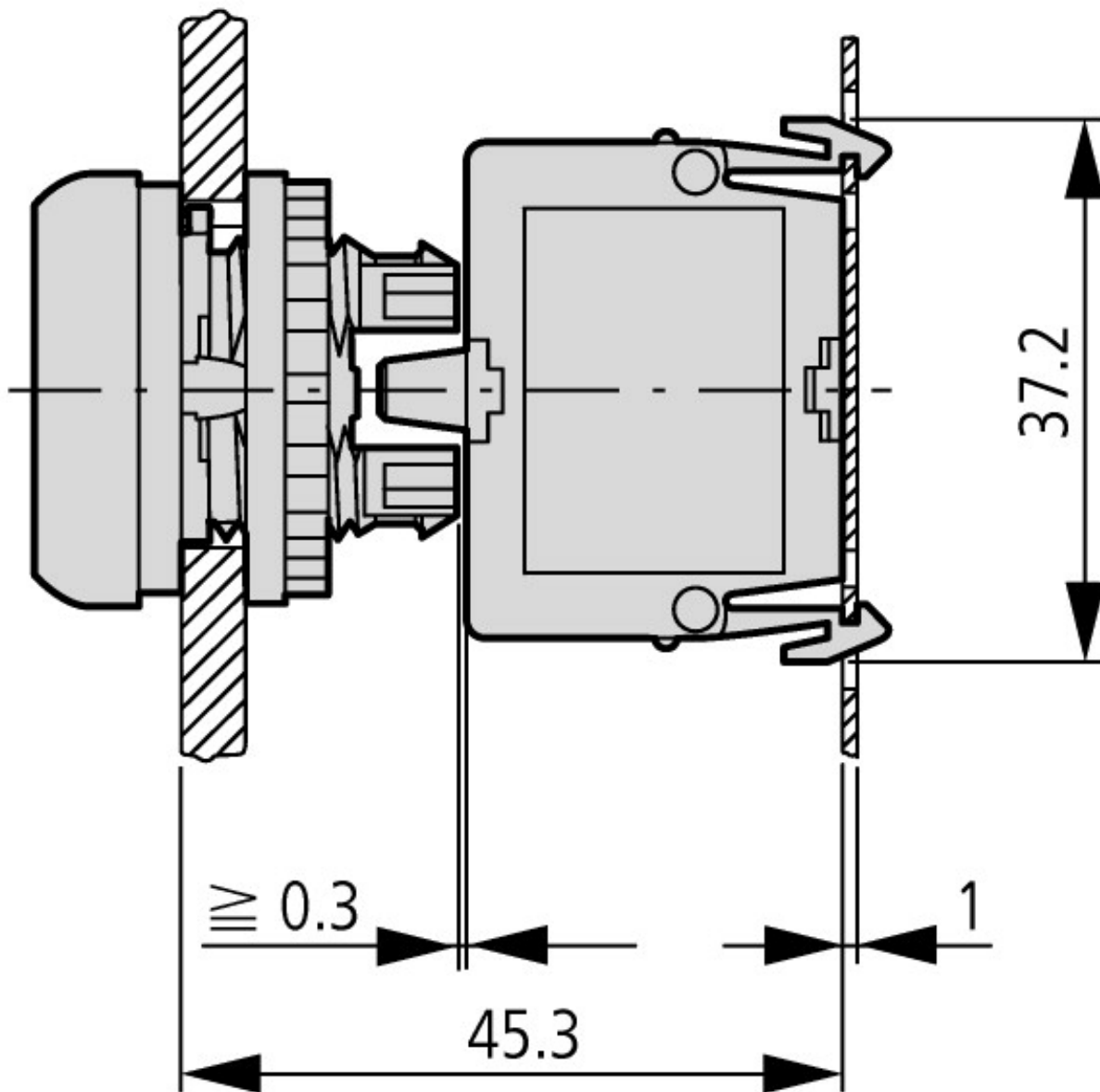

Pushbutton with M22-(C)K...  
Pushbutton with M22-(C) LED... + M22-XLED...

## Additional product information (links)

### IL04716002Z (AWA1160-1745) RMQ-Titan System

IL04716002Z (AWA1160-1745) RMQ-Titan System

[ftp://ftp.moeller.net/DOCUMENTATION/AWA\\_INSTRUCTIONS/IL04716002Z2017\\_01.pdf](ftp://ftp.moeller.net/DOCUMENTATION/AWA_INSTRUCTIONS/IL04716002Z2017_01.pdf)

DGUV Test Mark Customer Information

[http://www.dguv.de/medien/dguv-test-medien/\\_pdf\\_zip\\_doc\\_ppt/agb-und-pzo/dguv\\_test\\_zeichen\\_infoblatt\\_kunden.pdf](http://www.dguv.de/medien/dguv-test-medien/_pdf_zip_doc_ppt/agb-und-pzo/dguv_test_zeichen_infoblatt_kunden.pdf)