



Control relay, 24 V DC, 8DI(2AI), 4DO relays, display



Powering Business Worldwide™

Part no. EASY512-DC-R

Catalog No. 274108

EL-Nummer (Norway) 4519757

Delivery program

Product range			Control relays easyRelay
Basic function			easy500
Description			Stand alone customized laser inscription or delivery with user program possible with EASY-COMBINATION-* product (article No. 2010781)
Inputs			
Digital input count			digital: 8 digital: 8; of which can be used as analog: 2
Digital			8
of which can be used as analog			2
Outputs			
Type			Relay
Quantity of outputs			Relays: 4
Outputs		Number	4
Relay 10 A (UL)			4
Additional features			
Display			with display, with keypad
Display & keypad			✓
Supply voltage			24 V DC
Software			EASY-SOFT-BASIC/-PRO

Technical data

General

Standards			EN 55011, EN 55022, IEC/EN 61000-4, IEC 60068-2-6, IEC 60068-2-27
Dimensions (W x H x D)		mm	71.5 x 90 x 58 (4 PE)
Weight		kg	0.2
Mounting			Top-hat rail IEC/EN 60715, 35 mm or screw fixing using fixing brackets ZB4-101-GF1 (accessories)

Terminal capacities

Solid		mm ²	0.2/4 (AWG 22 - 12)
Flexible with ferrule		mm ²	0.2/2.5 (AWG 22 - 12)
Standard screwdriver		mm	3.5 x 0.8
Max. tightening torque		Nm	0.6

Climatic environmental conditions

Operating ambient temperature		°C	In accordance with IEC 60068-2-1, -25 - +55
Condensation			Take appropriate measures to prevent condensation
LCD display (clearly legible)		°C	0 - 55
Storage	8	°C	-40 - +70
relative humidity		%	in accordance with IEC 60068-2-30, IEC 60068-2-78 5 - 95
Air pressure (operation)		hPa	795 - 1080

Ambient conditions, mechanical

Protection type (IEC/EN 60529, EN50178, VBG 4)			IP20
Vibrations	3,5 mm / 1 g	Hz	In accordance with IEC 60068-2-6 constant amplitude 0.15 mm: 10 - 57 constant acceleration 2 g: 57 - 150
Mechanical shock resistance (IEC/EN 60068-2-27) semi-sinusoidal 15 g/11 ms		Impacts	18
Drop to IEC/EN 60068-2-31	Drop height	mm	50
Free fall, packaged (IEC/EN 60068-2-32)		m	1
Mounting position			Vertical or horizontal

Electromagnetic compatibility (EMC)

Overvoltage category/pollution degree			III/2
Electrostatic discharge (ESD)			
applied standard			according to IEC EN 61000-4-2
Air discharge		kV	8
Contact discharge		kV	6
Electromagnetic fields (RFI) to IEC EN 61000-4-3		V/m	10
Radio interference suppression			EN 55011 Class B, EN 55022 Class B
Burst		kV	according to IEC/EN 61000-4-4 Supply cables: 2 Signal cables: 2
power pulses (Surge)			according to IEC/EN 61000-4-5 1 kV (supply cables, symmetrical)
Immunity to line-conducted interference to (IEC/EN 61000-4-6)		V	10

Insulation resistance

Clearance in air and creepage distances			EN 50178, UL 508, CSA C22.2, No. 142
Insulation resistance			EN 50178



Repetition accuracy of timing relays

Accuracy of timing relays (of values)		%	± 1
Resolution			
Range "S"		ms	10
Range "M:S"		s	1
Range "H:M"		min	1





Retentive memory

Write cycles of the retentive memory			1000000 (10 ⁶)
--------------------------------------	--	--	----------------------------

Power supply

Rated operational voltage	U _e	V	24 DC (-15/+20%)
Permissible range	U _e		20.4 - 28.8 V DC
Residual ripple		%	 5
Input current			normally 80 mA at U _e
Voltage dips		ms	≤ In accordance with IEC 61131-2 ≤ 10
Fuse		A	 1A (T)
Power loss	P	W	Normally 2

Digital inputs 24 V DC

Number			8
Inputs can be used as analog inputs			2 (I7,I8)
Status Display			LCD-Display
Potential isolation			from power supply: no between digital inputs: no from the outputs: yes to interface/memory card: no
Rated operational voltage	U _e	V DC	24
Input voltage		V DC	Signal 0:  5 (I1 - I8) Signal 1:  15 (I1 - I6),  8 (I7, I8)
Input current at signal 1		mA	I1 - I6: 3.3 (at 24 V DC) I7, I8: 2.2 (at 24 V DC)
Deceleration time		ms	20 (0 -> 1/1 -> 0, Debounce ON) normally 0.25 (0 -> 1, Debounce OFF, I1 - I8)
Cable length		m	100 (unshielded)
Frequency counter			
Number			2 (I3, I4)
Counter frequency		kHz	 1
Pulse shape			Square
Pulse pause ratio			1:1
Cable length		m	 20 (screened)
Rapid counter inputs			
Number			2 (I1, I2)

Cable length		m	 20 (screened)
Counter frequency		kHz	< 1
Pulse shape			Square
Pulse pause ratio			1:1



Digital inputs 24 V DC

Status Display			LCD-Display
----------------	--	--	-------------

Analog inputs

Number			2 (I7, I8)
Potential isolation			from power supply: no between digital inputs: no from the outputs: yes to interface/memory card: no
Input type			DC voltage
Signal range			0-10 V DC
Resolution			0.01 V analog 0.01 V digital 10 Bit (value 0 - 1023)
Input impedance		kΩ	11.2
Accuracy of actual value			
Two EASY devices		%	± 3
Within a single device		%	± 2, (I7, I8, I11, I12) ± 0.12 V
Conversion time, analog/digital		ms	Input delay ON: 20; Input delay OFF: each cycle time
Input current		mA	< 1
Cable length		m	 30, screened

Relay outputs

Number			4
Outputs in groups of			1
Parallel switching of outputs for increased output			Not permissible
Protection of an output relay			Miniature circuit-breaker B16 or fuse 8 A (slow)
Potential isolation			from power supply: yes From the inputs: yes Safe isolation according to EN 50178: 300 V AC Basic isolation: 600 V AC
Lifespan, mechanical	Operations	x 10 ⁶	10
Contacts			
Conventional thermal current (10 A UL)		A	8
Recommended for load: 12 V AC/DC		mA	> 500
Short-circuit-proof cos φ = 1, characteristic B16 at 600 A		A	16
Short-circuit-proof cos φ = 0.5 to 0.7, characteristic B16 at 900 A		A	16
Rated impulse withstand voltage U _{imp} of contact coil		kV	6
Rated operational voltage	U _e	V AC	250
Rated insulation voltage	U _i	V AC	250
Safe isolation according to EN 50178		V AC	300 between coil and contact 300 between two contacts
Making capacity			
AC—15, 250 V AC, 3 A (600 ops./h)	Operations		300000
DC-13, L/R  150 ms, 24 V DC, 1 A (500 S/h)	Operations		200000
Breaking capacity			
AC-15, 250 V AC, 3 A (600 Ops./h)	Operations		300000
DC-13, L/R  150 ms, 24 V DC, 1 A (500 S/h)	Operations		200000
Filament bulb load			
1000 W at 230/240 V AC	Operations		25000
500 W at 115/120 V AC	Operations		25000
Fluorescent lamp load			
Fluorescent lamp load 10 x 58 W at 230/240 V AC			
With upstream electrical device	Operations		25000
Uncompensated	Operations		25000
Fluorescent lamp load 1 x 58 W at 230/240 V AC, conventional, compensated	Operations		25000

Switching frequency			
Mechanical operations		x 10 ⁶	10
Switching frequency		Hz	10
Resistive load/lamp load		Hz	2
Inductive load		Hz	0.5
UL/CSA			
Uninterrupted current at 240 V AC		A	10
Uninterrupted current at 24 V DC		A	8
AC			
Control Circuit Rating Codes (utilization category)			B 300 Light Pilot Duty
Max. rated operational voltage		V AC	300
max. thermal continuous current cos φ = 1 at B 300		A	5
max. make/break cos φ ≠ capacity 1 at B 300		VA	3600/360
DC			
Control Circuit Rating Codes (utilization category)			R 300 Light Pilot Duty
Max. rated operational voltage		V DC	300
Max. thermal uninterrupted current at R 300		A	1
Max. make/break capacity at R 300		VA	28/28

Supply voltage U_{Aux}

Power loss	P	W	2
------------	---	---	---

Design verification as per IEC/EN 61439

Technical data for design verification			
Rated operational current for specified heat dissipation	I _n	A	0
Heat dissipation per pole, current-dependent	P _{vid}	W	0
Equipment heat dissipation, current-dependent	P _{vid}	W	0
Static heat dissipation, non-current-dependent	P _{vs}	W	2
Heat dissipation capacity	P _{diss}	W	0
Operating ambient temperature min.		°C	-25
Operating ambient temperature max.		°C	55
IEC/EN 61439 design verification			
10.2 Strength of materials and parts			
10.2.2 Corrosion resistance			Meets the product standard's requirements.
10.2.3.1 Verification of thermal stability of enclosures			Meets the product standard's requirements.
10.2.3.2 Verification of resistance of insulating materials to normal heat			Meets the product standard's requirements.
10.2.3.3 Verification of resistance of insulating materials to abnormal heat and fire due to internal electric effects			Meets the product standard's requirements.
10.2.4 Resistance to ultra-violet (UV) radiation			Meets the product standard's requirements.
10.2.5 Lifting			Does not apply, since the entire switchgear needs to be evaluated.
10.2.6 Mechanical impact			Does not apply, since the entire switchgear needs to be evaluated.
10.2.7 Inscriptions			Meets the product standard's requirements.
10.3 Degree of protection of ASSEMBLIES			Meets the product standard's requirements.
10.4 Clearances and creepage distances			Meets the product standard's requirements.
10.5 Protection against electric shock			Does not apply, since the entire switchgear needs to be evaluated.
10.6 Incorporation of switching devices and components			Does not apply, since the entire switchgear needs to be evaluated.
10.7 Internal electrical circuits and connections			Is the panel builder's responsibility.
10.8 Connections for external conductors			Is the panel builder's responsibility.
10.9 Insulation properties			
10.9.2 Power-frequency electric strength			Is the panel builder's responsibility.
10.9.3 Impulse withstand voltage			Is the panel builder's responsibility.
10.9.4 Testing of enclosures made of insulating material			Is the panel builder's responsibility.
10.10 Temperature rise			The panel builder is responsible for the temperature rise calculation. Eaton will provide heat dissipation data for the devices.
10.11 Short-circuit rating			Is the panel builder's responsibility.
10.12 Electromagnetic compatibility			Is the panel builder's responsibility.

Technical data ETIM 6.0

PLC's (EG000024) / Logic module (EC001417)		
Electric engineering, automation, process control engineering / Control / Programmable logic control (SPS) / Logic module (ecl@ss8.1-27-24-22-16 [AKE539011])		
Supply voltage AC 50 Hz	V	0 - 0
Supply voltage AC 60 Hz	V	0 - 0
Supply voltage DC	V	20.4 - 28.8
Voltage type of supply voltage		DC
Switching current	A	8
Number of analogue inputs		2
Number of analogue outputs		0
Number of digital inputs		8
Number of digital outputs		4
With relay output		Yes
Number of HW-interfaces industrial Ethernet		0
Number of HW-interfaces PROFINET		0
Number of HW-interfaces RS-232		0
Number of HW-interfaces RS-422		0
Number of HW-interfaces RS-485		0
Number of HW-interfaces serial TTY		0
Number of HW-interfaces USB		0
Number of HW-interfaces parallel		0
Number of HW-interfaces Wireless		0
Number of HW-interfaces other		1
With optical interface		No
Supporting protocol for TCP/IP		No
Supporting protocol for PROFIBUS		No
Supporting protocol for CAN		No
Supporting protocol for INTERBUS		No
Supporting protocol for ASI		No
Supporting protocol for KNX		No
Supporting protocol for MODBUS		No
Supporting protocol for Data-Highway		No
Supporting protocol for DeviceNet		No
Supporting protocol for SUCONET		No
Supporting protocol for LON		No
Supporting protocol for PROFINET IO		No
Supporting protocol for PROFINET CBA		No
Supporting protocol for SERCOS		No
Supporting protocol for Foundation Fieldbus		No
Supporting protocol for EtherNet/IP		No
Supporting protocol for AS-Interface Safety at Work		No
Supporting protocol for DeviceNet Safety		No
Supporting protocol for INTERBUS-Safety		No
Supporting protocol for PROFIsafe		No
Supporting protocol for SafetyBUS p		No
Supporting protocol for other bus systems		No
Radio standard Bluetooth		No
Radio standard WLAN 802.11		No
Radio standard GPRS		No
Radio standard GSM		No
Radio standard UMTS		No
IO link master		No
Redundancy		No

With display			Yes
Degree of protection (IP)			IP20
Basic device			Yes
Expandable			No
Expansion device			No
With timer			No
Rail mounting possible			Yes
Wall mounting/direct mounting			Yes
Front build in possible			No
Rack-assembly possible			No
Suitable for safety functions			No
Category according to EN 954-1			
SIL according to IEC 61508			None
Performance level acc. to EN ISO 13849-1			None
Appendant operation agent (Ex ia)			No
Appendant operation agent (Ex ib)			No
Explosion safety category for gas			None
Explosion safety category for dust			None
Width		mm	71.5
Height		mm	90
Depth		mm	58

Approvals

Product Standards			IEC/EN see Technical Data; UL 508; CSA C22.2 No. 142-M1987; CSA C22.2 No. 213-M1987; CE marking
UL File No.			E135462
UL Category Control No.			NRAQ
CSA File No.			012528
CSA Class No.			2252-01 + 2258-02
North America Certification			UL listed, CSA certified
Degree of Protection			IEC: IP20, UL/CSA Type: -

Dimensions

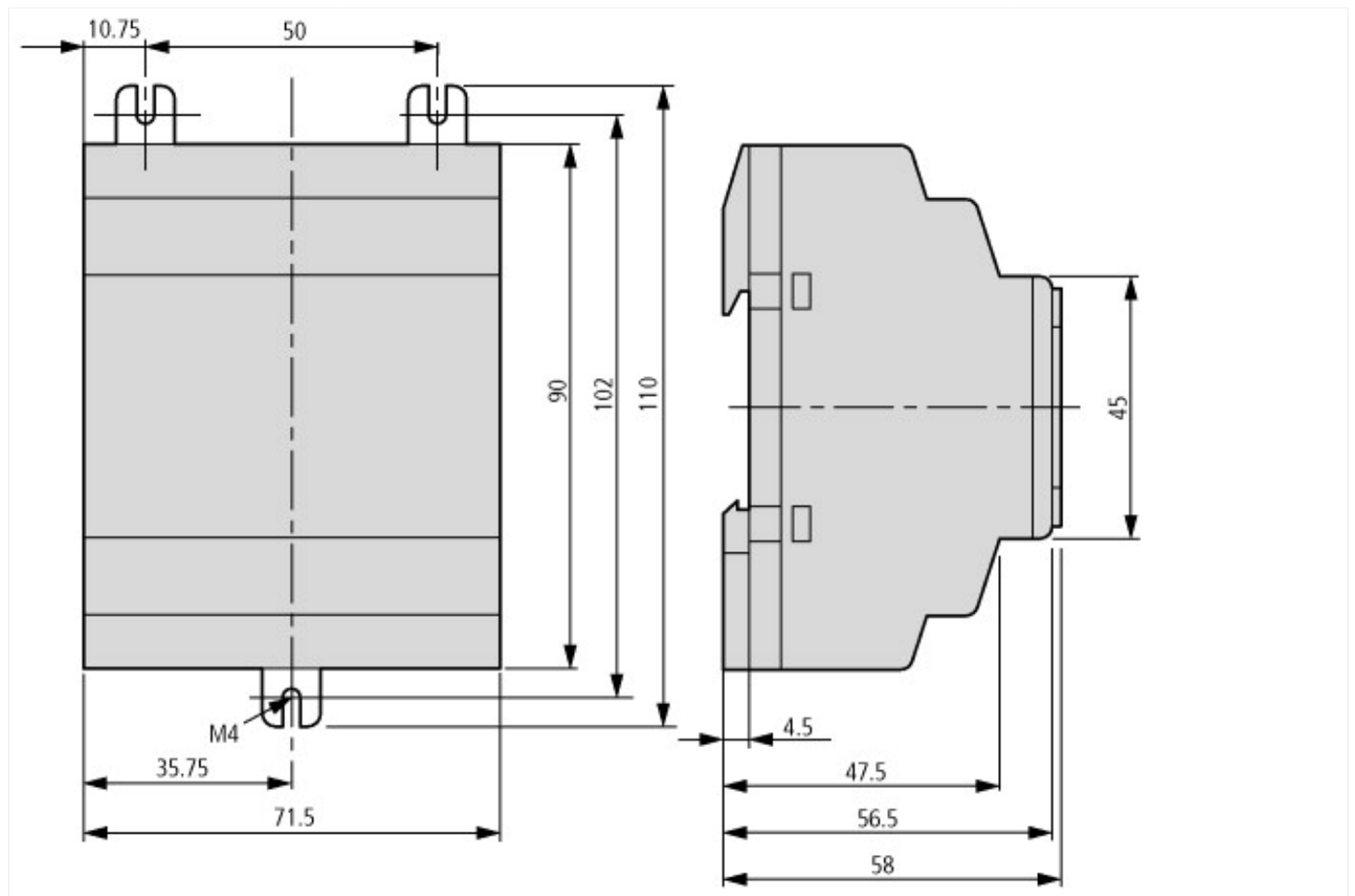

Additional product information (links)

Instruction leaflet "easy control relays" IL05013015Z (AWA2528-2105)

Instruction leaflet "easy control relays" IL05013015Z (AWA2528-2105) ftp://ftp.moeller.net/DOCUMENTATION/AWA_INSTRUCTIONS/IL05013015Z.pdf

Instruction leaflet "easy control relays" IL05013015Z (AWA2528-2105) ftp://ftp.moeller.net/DOCUMENTATION/AWA_INSTRUCTIONS/IL05013015Z2016_04.pdf

Manual "easy500, easy700 control relays" MN05013003Z (AWB2528-1508)

Handbuch Steuerrelais easy500, easy700 MN05013003Z (AWB2528-1508) - Deutsch ftp://ftp.moeller.net/DOCUMENTATION/AWB_MANUALS/MN05013003Z_DE.pdf

Manual "easy500, easy700 control relays" MN05013003Z (AWB2528-1508) - English ftp://ftp.moeller.net/DOCUMENTATION/AWB_MANUALS/MN05013003Z_EN.pdf

f1=1454&f2=1179;Labeleditor <http://applications.eaton.eu/sdlc?LX=11&f1=1454&f2=1179;Labeleditor>