







**Circuit-breaker, 3p, 160A**

**Part no. NZMB2-A160**  
**Catalog No. 259088**

**Delivery program**

Product range			Circuit-breaker
Protective function			System and cable protection
Standard/Approval			IEC
Installation type			Fixed
Release system			Thermomagnetic release
Construction size			NZM2
Number of poles			3 pole
Standard equipment			Screw connection
<b>Switching capacity</b>			
400/415 V 50 Hz	$I_{cu}$	kA	25
<b>Rated current = rated uninterrupted current</b>			
Rated current = rated uninterrupted current	$I_n = I_u$	A	160
<b>Setting range</b>			
Overload trip			
	$I_r$	A	125 - 160
Short-circuit releases			
			
Non-delayed	$I_i = I_n \times \dots$		6 - 10
			
Short-circuit releases	$I_{rm}$	A	960 - 1600
			

**Technical data**

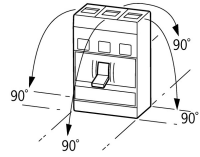
<b>General</b>			
Standards			IEC/EN 60947
Protection against direct contact			Finger and back of hand proof to VDE 0106 Part 100
Climatic proofing			Damp heat, constant, to IEC 60068-2-78 Damp heat, cyclic, to IEC 60068-2-30
Ambient temperature			
Ambient temperature, storage		°C	-40 - +70
Operation		°C	-25 - +70
Mechanical shock resistance (10 ms half-sinusoidal shock) according to IEC 60068-2-27		g	20 (half-sinusoidal shock 20 ms)
Safe isolation to EN 61140			
Between auxiliary contacts and main contacts		V AC	500
between the auxiliary contacts		V AC	300
Weight		kg	2.345
Mounting position			Vertical and 90° in all directions
			 <p>With XFI earth-fault release:  - NZM1, N1, NZM2, N2: vertical and 90° in all directions with plug-in unit  - NZM1, N1, NZM2, N2: vertical, 90° right/left with withdrawable unit:  - NZM3, N3: vertical, 90° right/left  - NZM4, N4: vertical</p>

with remote operator:  
 - NZM2, N(S)2, NZM3, N(S)3,  
 NZM4, N(S)4: vertical and 90° in all  
 directions

Direction of incoming supply		as required
Degree of protection		
Device		In the operating controls area: IP20 (basic degree of protection)
Enclosures		With insulating surround: IP40 With door coupling rotary handle: IP66
Terminations		Tunnel terminal: IP10 Phase isolator and strip terminal: IP00
Other technical data (sheet catalogue)		Temperature dependency, Derating

### Circuit-breakers

Rated current = rated uninterrupted current	$I_n = I_u$	A	160
Rated surge voltage invariability	$U_{imp}$		
Main contacts		V	8000
Auxiliary contacts		V	6000
Rated operational voltage	$U_e$	V AC	440
Overvoltage category/pollution degree			III/3
Rated insulation voltage	$U_i$	V	690
Use in unearthed supply systems		V	 440

### Switching capacity

Rated short-circuit making capacity	$I_{cm}$		
240 V	$I_{cm}$	kA	63
400/415 V	$I_{cm}$	kA	53
440 V 50/60 Hz	$I_{cm}$	kA	53
Rated short-circuit breaking capacity $I_{cn}$	$I_{cn}$		
$I_{cu}$ to IEC/EN 60947 test cycle O-t-CO	$I_{cu}$	kA	
240 V 50/60 Hz	$I_{cu}$	kA	30
400/415 V 50/60 Hz	$I_{cu}$	kA	25
440 V 50/60 Hz	$I_{cu}$	kA	25
$I_{cs}$ to IEC/EN 60947 test cycle O-t-CO-t-CO	$I_{cs}$	kA	
240 V 50/60 Hz	$I_{cs}$	kA	30
400/415 V 50/60 Hz	$I_{cs}$	kA	25
440 V 50/60 Hz	$I_{cs}$	kA	18.5
			Maximum back-up fuse, if the expected short-circuit currents at the installation location exceed the switching capacity of the circuit-breaker.
Utilization category to IEC/EN 60947-2			A
Rated making and breaking capacity			
Rated operational current	$I_e$	A	
AC-1			
380 V 400 V	$I_e$	A	160
415 V	$I_e$	A	160
AC--3			
380 V 400 V	$I_e$	A	160
415 V	$I_e$	A	160
Lifespan, mechanical(of which max. 50 % trip by shunt/undervoltage release)	Operations		20000
Lifespan, electrical			
AC-1			
400 V 50/60 Hz	Operations		10000
415 V 50/60 Hz	Operations		7500
Max. operating frequency		Ops/h	120
Total downtime in a short-circuit		ms	< 10

### Terminal capacity

Standard equipment		Screw connection
Optional accessories		Box terminal Tunnel terminal

			connection on rear
Round copper conductor			
Box terminal			
Solid		mm <sup>2</sup>	1 x (10 - 16) 2 x (6 - 16)
Stranded		mm <sup>2</sup>	1 x (25 - 185) 2 x (25 - 70)
Tunnel terminal			
Solid		mm <sup>2</sup>	1 x 16
Stranded		mm <sup>2</sup>	
1-hole		mm <sup>2</sup>	1 x (25 - 185)
Bolt terminal and rear-side connection			
Direct on the switch			
Solid		mm <sup>2</sup>	1 x (10 - 16) 2 x (6 - 16)
Stranded		mm <sup>2</sup>	1 x (25 - 185) 2 x (25 - 70)
Al conductors, Cu cable			
Solid		mm <sup>2</sup>	1 x 16
Stranded		mm <sup>2</sup>	
Stranded		mm <sup>2</sup>	1 x (25 - 185)
Cu strip (number of segments x width x segment thickness)			
Box terminal			
	min.	mm	2 x 9 x 0.8
	max.	mm	10 x 16 x 0.8 (2x) 8 x 15.5 x 0,8
Bolt terminal and rear-side connection			
Flat copper strip, with holes	min.	mm	2 x 16 x 0.8
Flat copper strip, with holes	max.	mm	10 x 24 x 0.8
Copper busbar (width x thickness)		mm	
Bolt terminal and rear-side connection			
Screw connection			M8
Direct on the switch			
	min.	mm	16 x 5
	max.	mm	24 x 8
Control cables			
		mm <sup>2</sup>	1 x (0.75 - 2.5) 2 x (0.75 - 1.5)

## Design verification as per IEC/EN 61439

Technical data for design verification			
Rated operational current for specified heat dissipation	I <sub>n</sub>	A	160
Equipment heat dissipation, current-dependent	P <sub>vid</sub>	W	38.4
Operating ambient temperature max.		°C	-25
Operating ambient temperature max.		°C	70
IEC/EN 61439 design verification			
10.2 Strength of materials and parts			
10.2.2 Corrosion resistance			
			Meets the product standard's requirements.
10.2.3.1 Verification of thermal stability of enclosures			
			Meets the product standard's requirements.
10.2.3.2 Verification of resistance of insulating materials to normal heat			
			Meets the product standard's requirements.
10.2.3.3 Verification of resistance of insulating materials to abnormal heat and fire due to internal electric effects			
			Meets the product standard's requirements.
10.2.4 Resistance to ultra-violet (UV) radiation			
			Meets the product standard's requirements.
10.2.5 Lifting			
			Does not apply, since the entire switchgear needs to be evaluated.
10.2.6 Mechanical impact			
			Does not apply, since the entire switchgear needs to be evaluated.
10.2.7 Inscriptions			
			Meets the product standard's requirements.

10.3 Degree of protection of ASSEMBLIES		Does not apply, since the entire switchgear needs to be evaluated.
10.4 Clearances and creepage distances		Meets the product standard's requirements.
10.5 Protection against electric shock		Does not apply, since the entire switchgear needs to be evaluated.
10.6 Incorporation of switching devices and components		Does not apply, since the entire switchgear needs to be evaluated.
10.7 Internal electrical circuits and connections		Is the panel builder's responsibility.
10.8 Connections for external conductors		Is the panel builder's responsibility.
10.9 Insulation properties		
10.9.2 Power-frequency electric strength		Is the panel builder's responsibility.
10.9.3 Impulse withstand voltage		Is the panel builder's responsibility.
10.9.4 Testing of enclosures made of insulating material		Is the panel builder's responsibility.
10.10 Temperature rise		The panel builder is responsible for the temperature rise calculation. Eaton will provide heat dissipation data for the devices.
10.11 Short-circuit rating		Is the panel builder's responsibility. The specifications for the switchgear must be observed.
10.12 Electromagnetic compatibility		Is the panel builder's responsibility. The specifications for the switchgear must be observed.
10.13 Mechanical function		The device meets the requirements, provided the information in the instruction leaflet (IL) is observed.

## Technical data ETIM 6.0

Low-voltage industrial components (EG000017) / Power circuit-breaker for trafo/generator/installation prot. (EC000228)		
Electric engineering, automation, process control engineering / Low-voltage switch technology / Circuit breaker (LV < 1 kV) / Circuit breaker for power transformer, generator and system protection (ecl@ss8.1-27-37-04-09 [AJZ716010])		
Rated permanent current I <sub>u</sub>	A	160
Rated voltage	V	440 - 440
Rated short-circuit breaking capacity I <sub>cu</sub> at 400 V, 50 Hz	kA	25
Overload release current setting	A	125 - 160
Adjustment range short-term delayed short-circuit release	A	0 - 0
Adjustment range undelayed short-circuit release	A	960 - 1600
Integrated earth fault protection		No
Type of electrical connection of main circuit		Screw connection
Device construction		Built-in device fixed built-in technique
Suitable for DIN rail (top hat rail) mounting		No
DIN rail (top hat rail) mounting optional		Yes
Number of auxiliary contacts as normally closed contact		0
Number of auxiliary contacts as normally open contact		0
Number of auxiliary contacts as change-over contact		0
Switched-off indicator available		No
With under voltage release		No
Number of poles		3
Position of connection for main current circuit		Front side
Type of control element		Rocker lever
Complete device with protection unit		Yes
Motor drive integrated		No
Motor drive optional		Yes
Degree of protection (IP)		IP20

# Characteristics

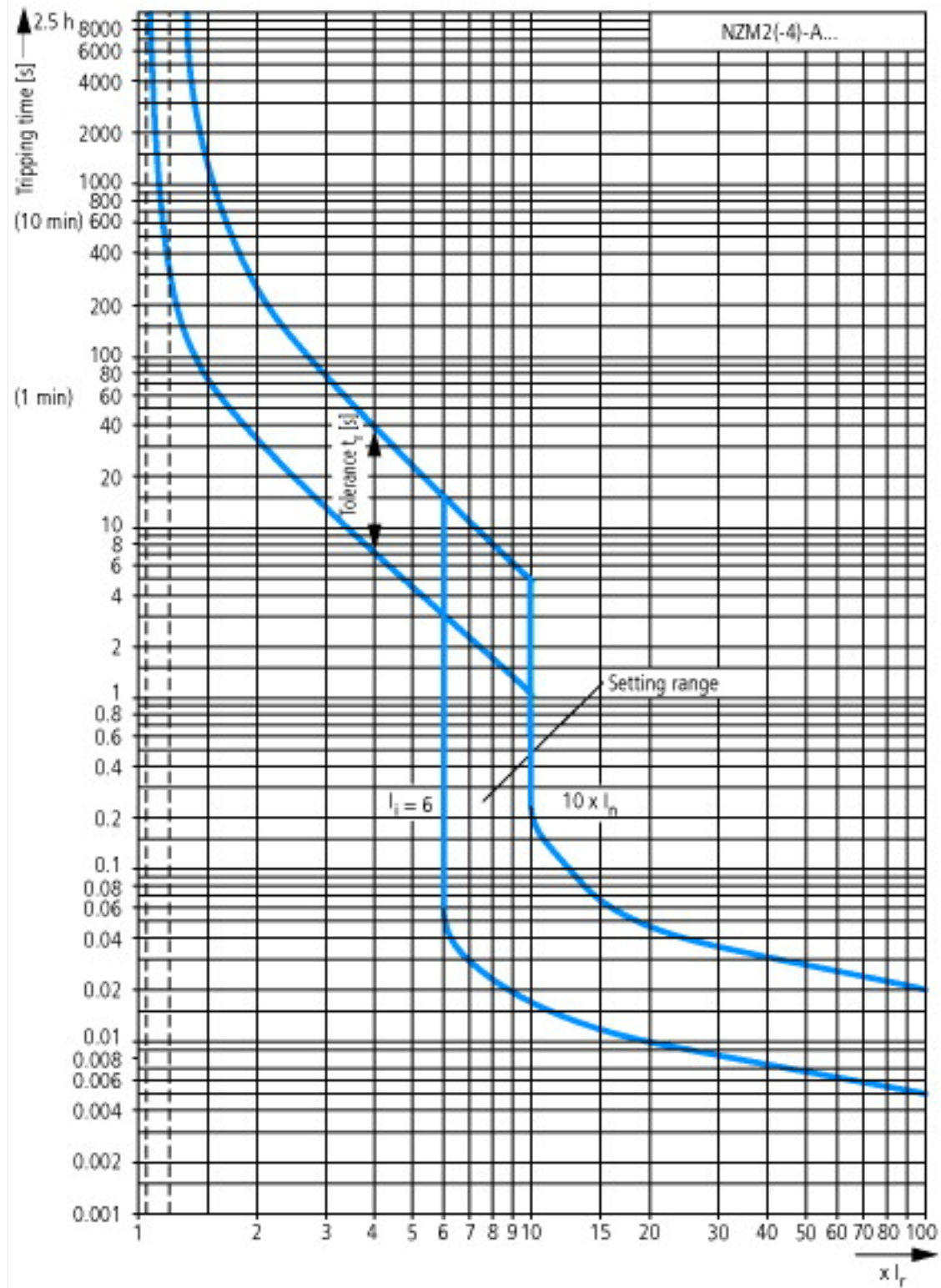

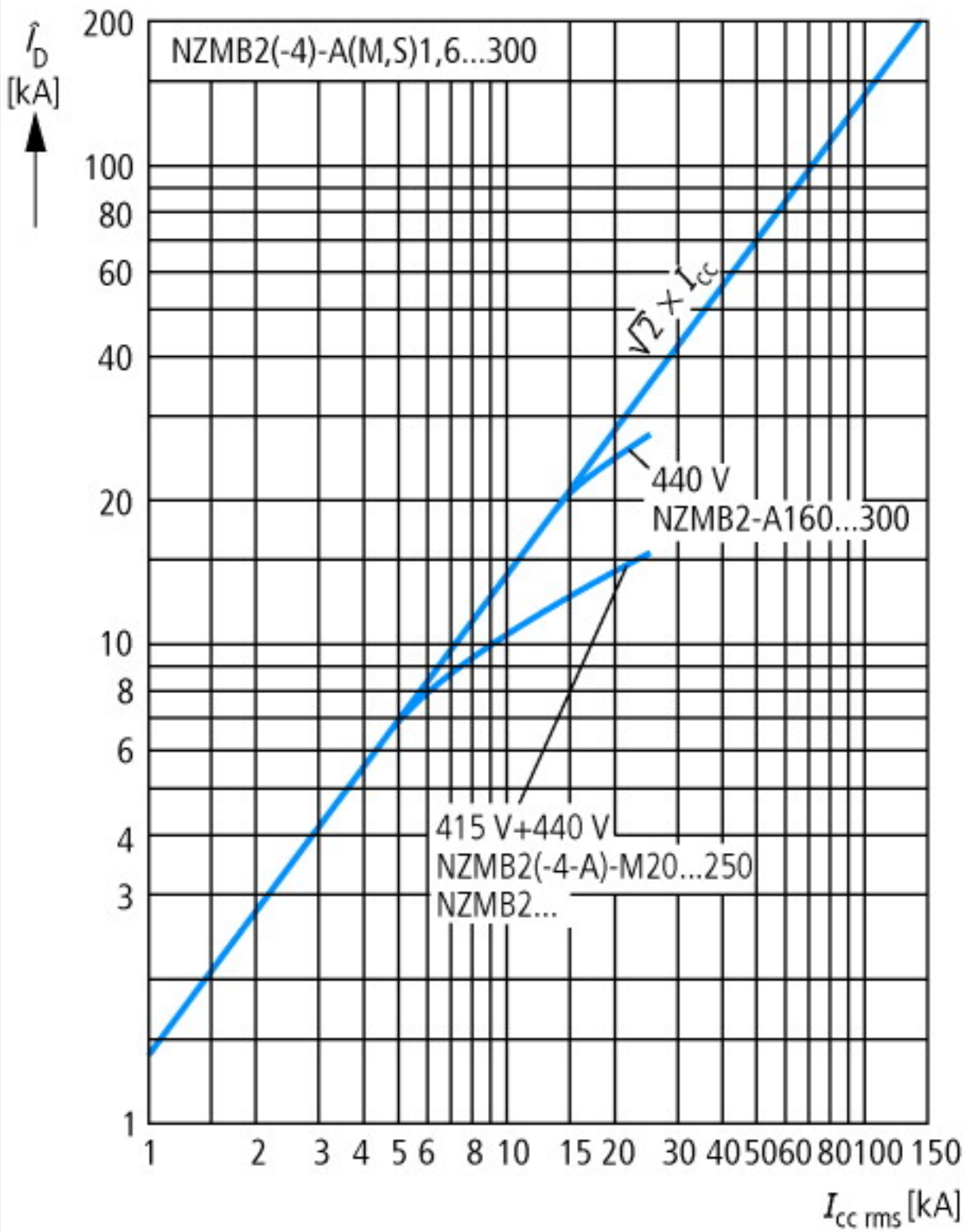

Let-through current

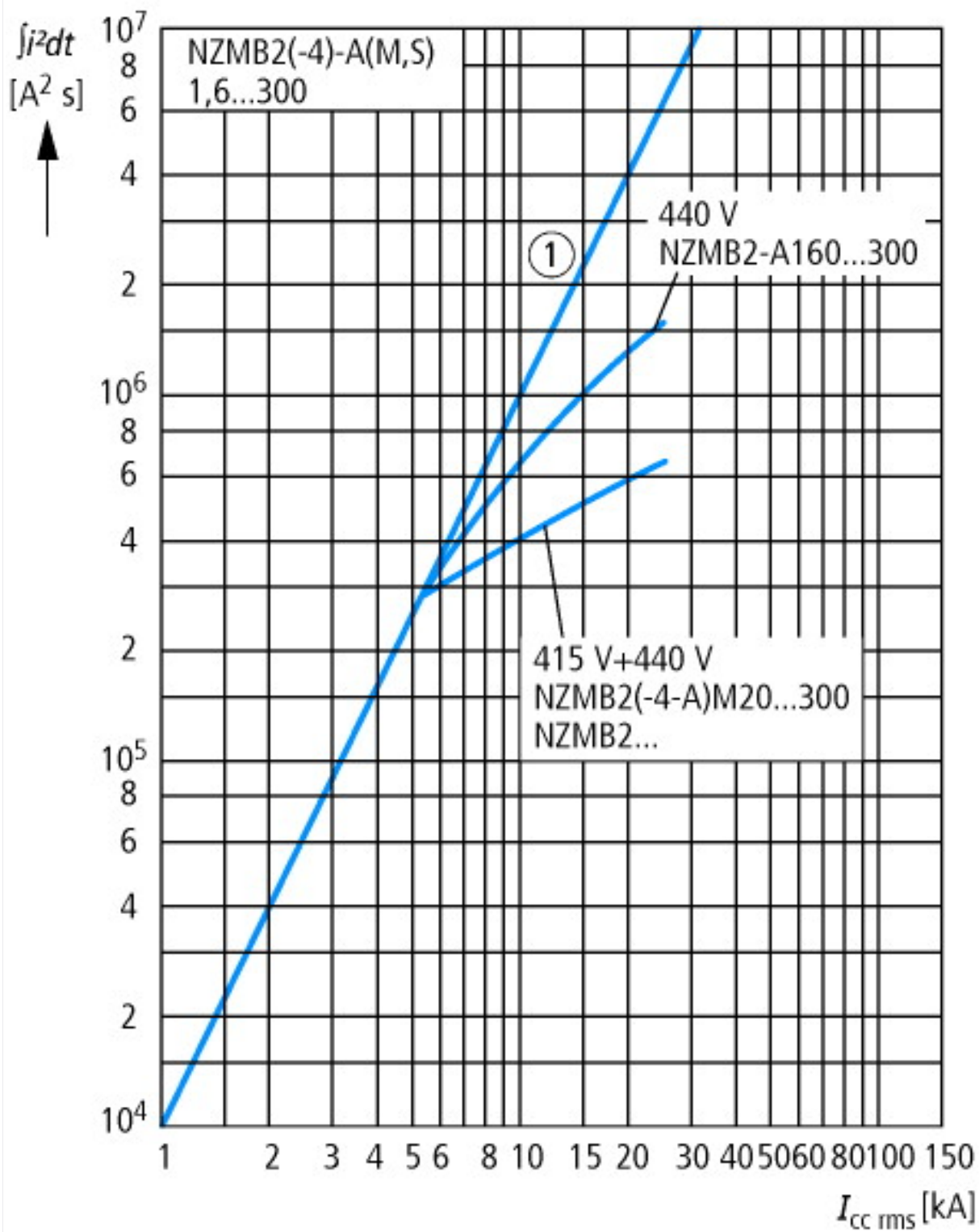

Let-through energy

## Dimensions

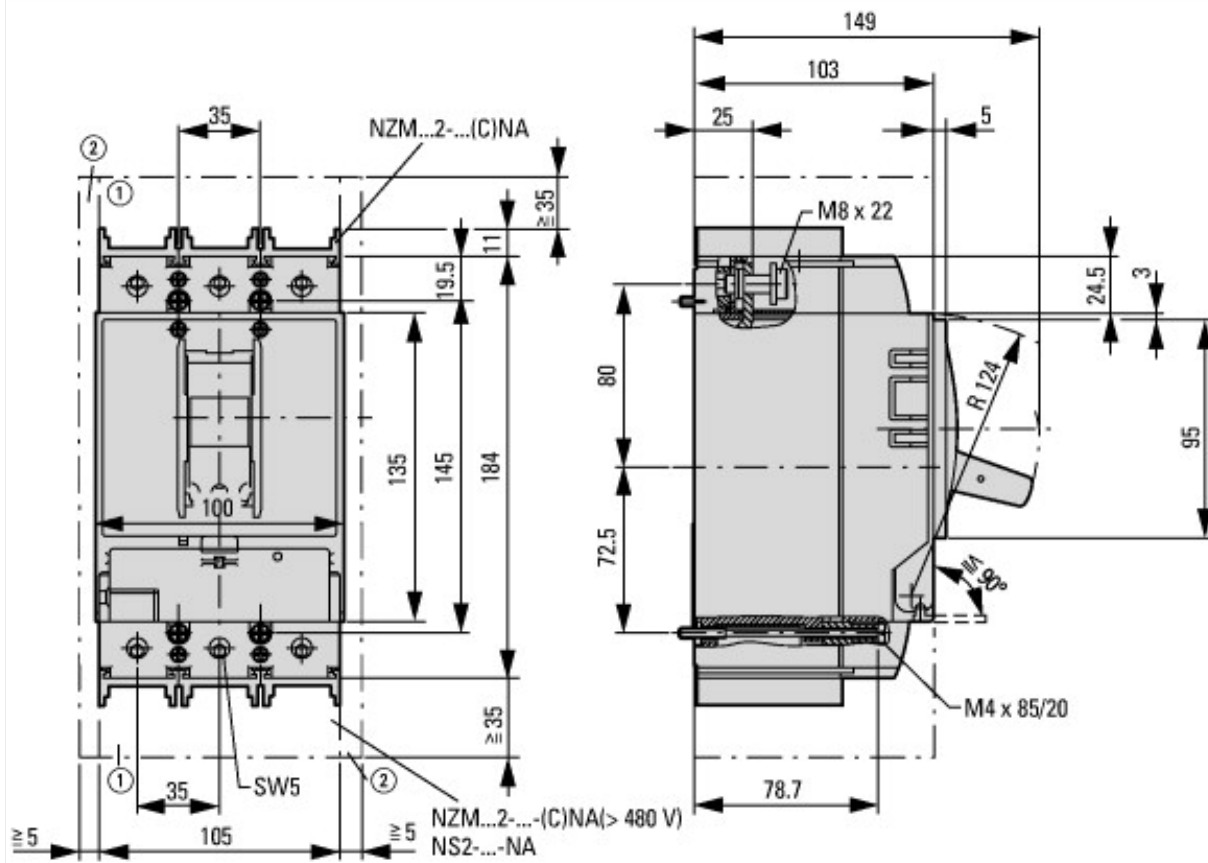

- ① Blow out area, minimum clearance to adjacent parts
- ② Minimum clearance to adjacent parts



### Additional product information (links)

#### IL01206006Z (AWA1230-1916) Circuit-Breaker, basic unit

IL01206006Z (AWA1230-1916) Circuit-Breaker, basic unit [ftp://ftp.moeller.net/DOCUMENTATION/AWA\\_INSTRUCTIONS/IL01206006Z2015\\_11.pdf](ftp://ftp.moeller.net/DOCUMENTATION/AWA_INSTRUCTIONS/IL01206006Z2015_11.pdf)

Temperature dependency, Derating <http://ecat.moeller.net/flip-cat/?edition=HPLEN&startpage=17.172>

CurveSelect characteristics program <http://www.eaton.eu/DE/Europe/Electrical/CustomerSupport/ConfigurationTools/CharacteristicsProgram/index.htm>