



Contactor relay, 3N/O+1N/C, DC current

Part no. DILA-31(24VDC)
Catalog No. 276379
Eaton Catalog No. XTRE10B31TD
EL-Nummer (Norway) 4130206



Powering Business Worldwide™



Delivery program



Product range				DILA relays
Application				Contactor relays
Description				Basic devices with positive operation contacts
Connection technique				Screw terminals
Rated operational current				
AC-15				
220 V 230 V 240 V	I_e	A		4
380 V 400 V 415 V	I_e	A		4
Contacts				
N/O = Normally open				3 N/O
N/C = Normally closed				1 NC
Contact sequence				
Code number and version of combination				
Distinctive number				31E
Can be combined with auxiliary contact module				DILA-XHI(V)...
Actuating voltage				24 V DC
Voltage AC/DC				DC operation
Suppressor circuit				built-in
Instructions				Contact numbers to EN 50011 Coil terminal markings to EN 50005 built-in suppressor circuit'

Technical data

General				
Standards				IEC/EN 60947, EN 60947-5-1, VDE 0660, UL, CSA
Lifespan, mechanical				
DC operated	Operations	$\times 10^6$		20
Maximum operating frequency	Operations/h			9000
Climatic proofing				Damp heat, constant, to IEC 60068-2-78 Damp heat, cyclic, to IEC 60068-2-30
Ambient temperature				
Open		°C		-25 - +60
Enclosed		°C		- 25 - 40
Ambient temperature, storage		°C		- 40 - 80
Mounting position				
Mounting position				
Mechanical shock resistance (IEC/EN 60068-2-27)				
Half-sinusoidal shock, 10 ms				
Basic unit with auxiliary contact module		g		
N/O contact		g		7
N/C contact		g		5

Degree of Protection			IP20
Protection against direct contact when actuated from front (EN 50274)			Finger and back-of-hand proof
Weight			
DC operated		kg	0.294
Terminal capacities		mm ²	
Screw terminals			
Solid		mm ²	1 x (0,75 - 4) 2 x (0,75 - 2,5)
Flexible with ferrule		mm ²	1 x (0.75 - 2.5) 2 x (0.75 - 2.5)
Solid or stranded		AWG	18 - 14
Stripping length		mm	10
Terminal screw			M3.5
Pozidriv screwdriver		Size	2
Standard screwdriver		mm	0.8 x 5.5 1 x 6
Max. tightening torque		Nm	1.2

Contacts

Positive operating contacts to ZH 1/457, including auxiliary contact module			Yes
Rated impulse withstand voltage	U_{imp}	V AC	6000
Overvoltage category/pollution degree			III/3
Rated insulation voltage	U_i	V AC	690
Rated operational voltage	U_e	V AC	690
Safe isolation to EN 61140			
between coil and auxiliary contacts		V AC	400
between the auxiliary contacts		V AC	400
Rated operational current		A	
Conventional free air thermal current, 1 pole			
Open			
at 60 °C	$I_{th} = I_e$	A	16
AC-15			
220 V 230 V 240 V	I_e	A	4
380 V 400 V 415 V	I_e	A	4
500 V	I_e	A	1.5
DC current			
DC L/R  15 ms			
Contacts in series:		A	
1	24 V	A	10
1	60 V	A	6
2	60 V	A	10
1	110 V	A	3
3	110 V	A	6
1	220 V	A	1
3	220 V	A	5
DC L/R  50 ms			
Contacts in series:		A	
3	24 V	A	4
3	60 V	A	4
3	110 V	A	2
3	220 V	A	1
Control circuit reliability	Failure rate	λ	$<10^{-8}$, < one failure at 100 million operations (at $U_e = 24$ V DC, $U_{min} = 17$ V, $I_{min} = 5.4$ mA)
Short-circuit rating without welding			
Maximum overcurrent protective device			
220 V 230 V 240 V		PKZM0	4

380 V 400 V 415 V		PKZM0	4
Short-circuit protection maximum fuse			
500 V		A gG/gL	10
Current heat loss at I_{th}			
DC operated		W	0.85

Magnet systems

Voltage tolerance			
DC operated			
Pick-up voltage			
Pick-up voltage min.		$x U_c$	0.8
Pick-up voltage max.		$x U_c$	1.1
at 24 V: without auxiliary contact component (40 °C)	Pick-up	$x U_c$	
Voltage tolerance, DC coil without auxiliary contact module, min. pick-up voltage		$x U_c$	0.7
Without auxiliary contact module	Pick-up	$x U_c$	1.3
Power consumption			
DC operated	Pull-in = sealing	W	2.6
duty factor		% DF	100
Changeover time at 100 % U_c (recommended value)			
DC operated closing delay		ms	
Switching times, DC operated, max. closing delay		ms	31
DC operated N/O contact opening delay		ms	
Switching times, DC actuated make contact Opening delay, max.		ms	12

Notes

Notes Making and breaking conditions to DC-13, time constant as stated
Smoothed DC, three-phase bridge rectifiers or smoothed double-wave rectification

Rating data for approved types

Auxiliary contacts			
Pilot Duty			
AC operated			A600
DC operated			P300
General Use			
AC		V	600
AC		A	15
DC		V	250
DC		A	1

Design verification as per IEC/EN 61439

Technical data for design verification			
Rated operational current for specified heat dissipation	I_n	A	15.5
Heat dissipation per pole, current-dependent	P_{vid}	W	1
Equipment heat dissipation, current-dependent	P_{vid}	W	0
Static heat dissipation, non-current-dependent	P_{vs}	W	2.6
Heat dissipation capacity	P_{diss}	W	0
Operating ambient temperature max.		°C	-25
Operating ambient temperature max.		°C	60
IEC/EN 61439 design verification			
10.2 Strength of materials and parts			
10.2.2 Corrosion resistance			Meets the product standard's requirements.
10.2.3.1 Verification of thermal stability of enclosures			Meets the product standard's requirements.
10.2.3.2 Verification of resistance of insulating materials to normal heat			Meets the product standard's requirements.
10.2.3.3 Verification of resistance of insulating materials to abnormal heat and fire due to internal electric effects			Meets the product standard's requirements.
10.2.4 Resistance to ultra-violet (UV) radiation			Meets the product standard's requirements.
10.2.5 Lifting			Does not apply, since the entire switchgear needs to be evaluated.
10.2.6 Mechanical impact			Does not apply, since the entire switchgear needs to be evaluated.

10.2.7 Inscriptions		Meets the product standard's requirements.
10.3 Degree of protection of ASSEMBLIES		Does not apply, since the entire switchgear needs to be evaluated.
10.4 Clearances and creepage distances		Meets the product standard's requirements.
10.5 Protection against electric shock		Does not apply, since the entire switchgear needs to be evaluated.
10.6 Incorporation of switching devices and components		Does not apply, since the entire switchgear needs to be evaluated.
10.7 Internal electrical circuits and connections		Is the panel builder's responsibility.
10.8 Connections for external conductors		Is the panel builder's responsibility.
10.9 Insulation properties		
10.9.2 Power-frequency electric strength		Is the panel builder's responsibility.
10.9.3 Impulse withstand voltage		Is the panel builder's responsibility.
10.9.4 Testing of enclosures made of insulating material		Is the panel builder's responsibility.
10.10 Temperature rise		The panel builder is responsible for the temperature rise calculation. Eaton will provide heat dissipation data for the devices.
10.11 Short-circuit rating		Is the panel builder's responsibility. The specifications for the switchgear must be observed.
10.12 Electromagnetic compatibility		Is the panel builder's responsibility. The specifications for the switchgear must be observed.
10.13 Mechanical function		The device meets the requirements, provided the information in the instruction leaflet (IL) is observed.

Technical data ETIM 6.0

Low-voltage industrial components (EG000017) / Contactor relay (EC000196)		
Electric engineering, automation, process control engineering / Low-voltage switch technology / Contactor (LV) / Contactor relay (ecl@ss8.1-27-37-10-01 [AAB716011])		
Rated control supply voltage U_s at AC 50HZ	V	0 - 0
Rated control supply voltage U_s at AC 60HZ	V	0 - 0
Rated control supply voltage U_s at DC	V	24 - 24
Voltage type for actuating		DC
Rated operation current I_e , 400 V	A	4
Connection type auxiliary circuit		Screw connection
Mounting method		DIN-rail/screw
Interface		No
Number of auxiliary contacts as normally closed contact		1
Number of auxiliary contacts as normally open contact		3
Number of auxiliary contacts as normally closed contact, delayed switching		0
Number of auxiliary contacts as normally open contact, leading		0
With LED indication		No
Number of auxiliary contacts as change-over contact		0
Manual operation possible		No

Approvals

Product Standards		IEC/EN 60947-4-1; UL 60947-4-1; CSA - C22.2 No. 60947-4-1-14; CE marking
UL File No.		E29184
UL Category Control No.		NKCR
CSA File No.		012528
CSA Class No.		3211-03
North America Certification		UL listed, CSA certified
Specially designed for North America		No

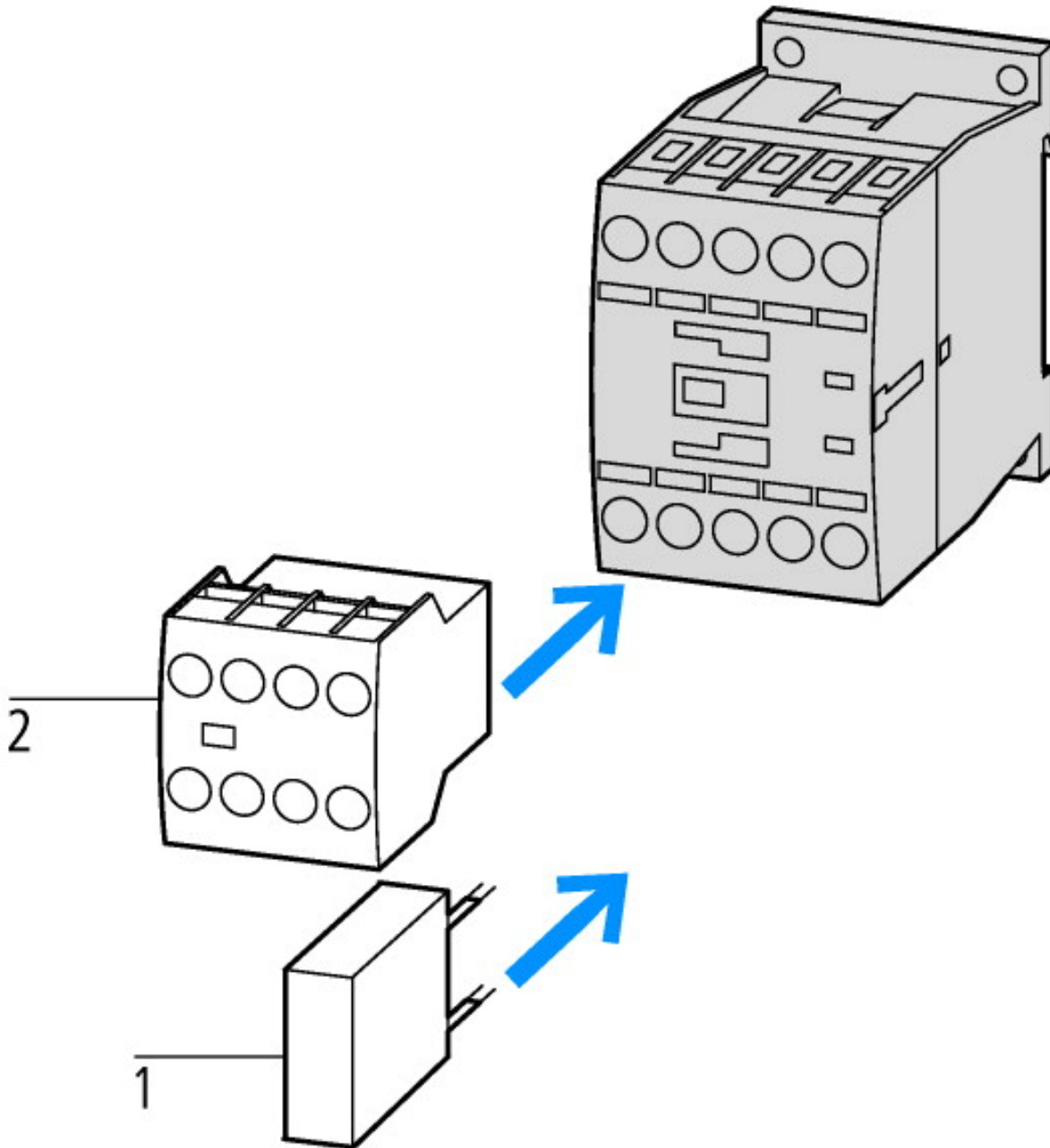

- 1: Suppressor
- 2: Auxiliary contact module

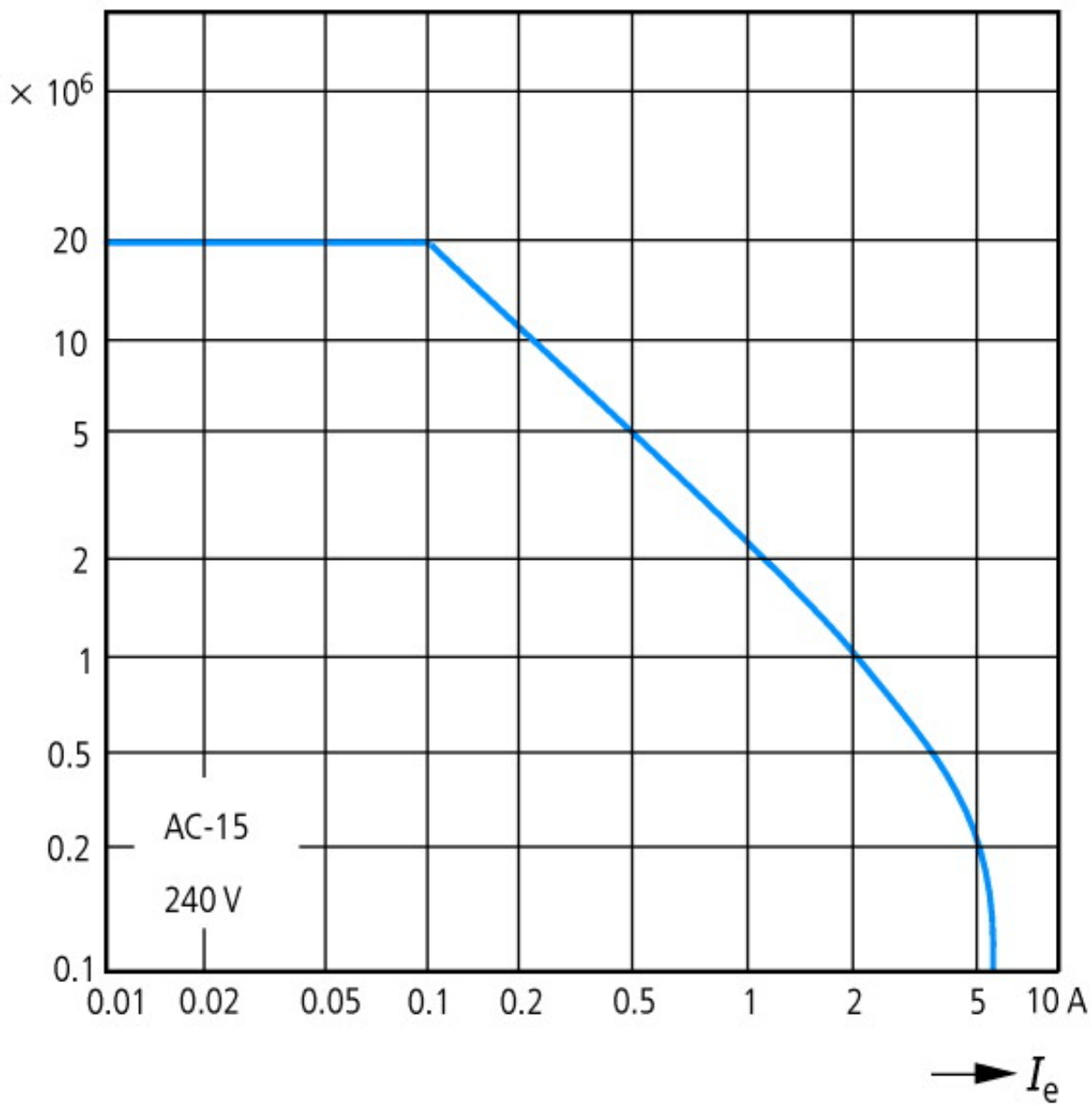

Component lifespan (operations)
 I_e = Rated operational current

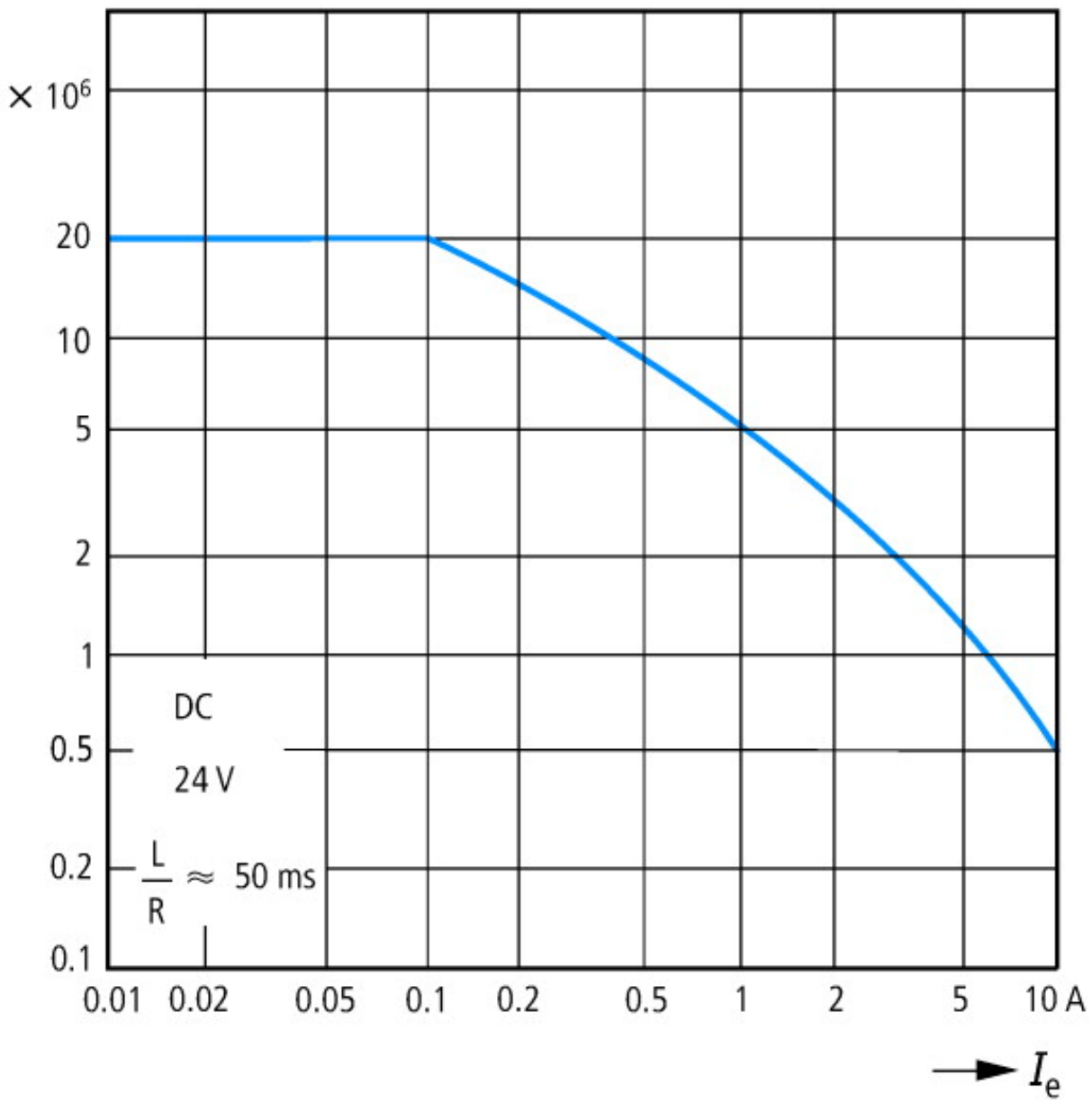

Component lifespan (operations)
 I_e = Rated operational current

Dimensions

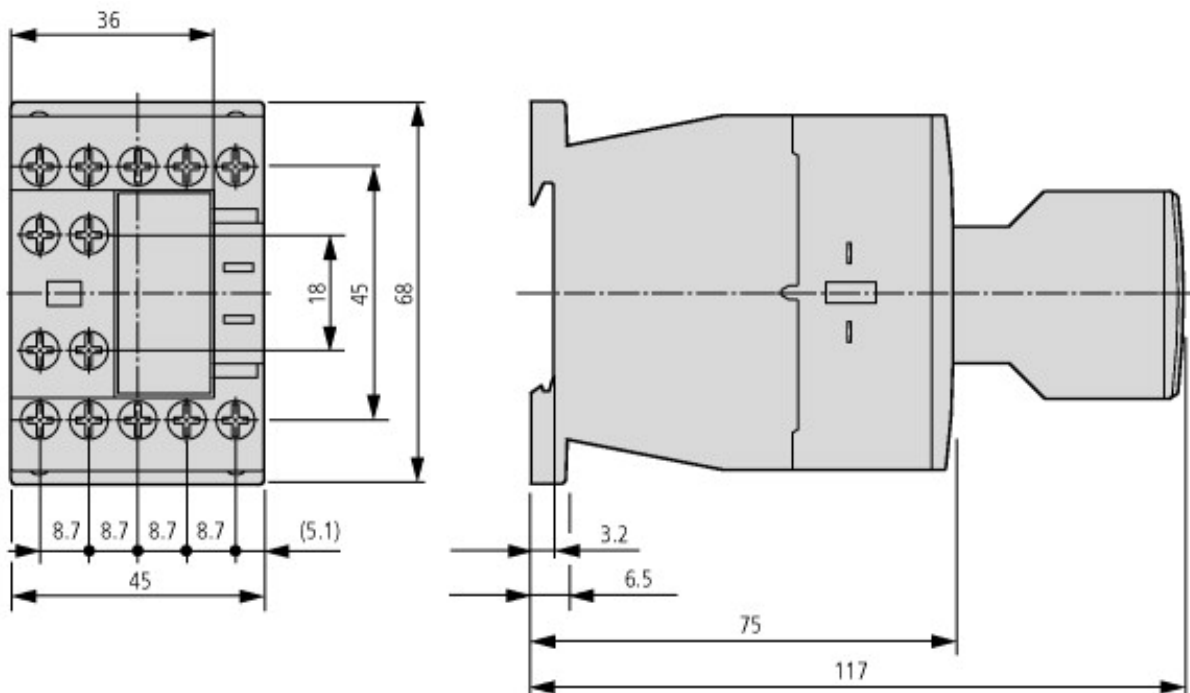

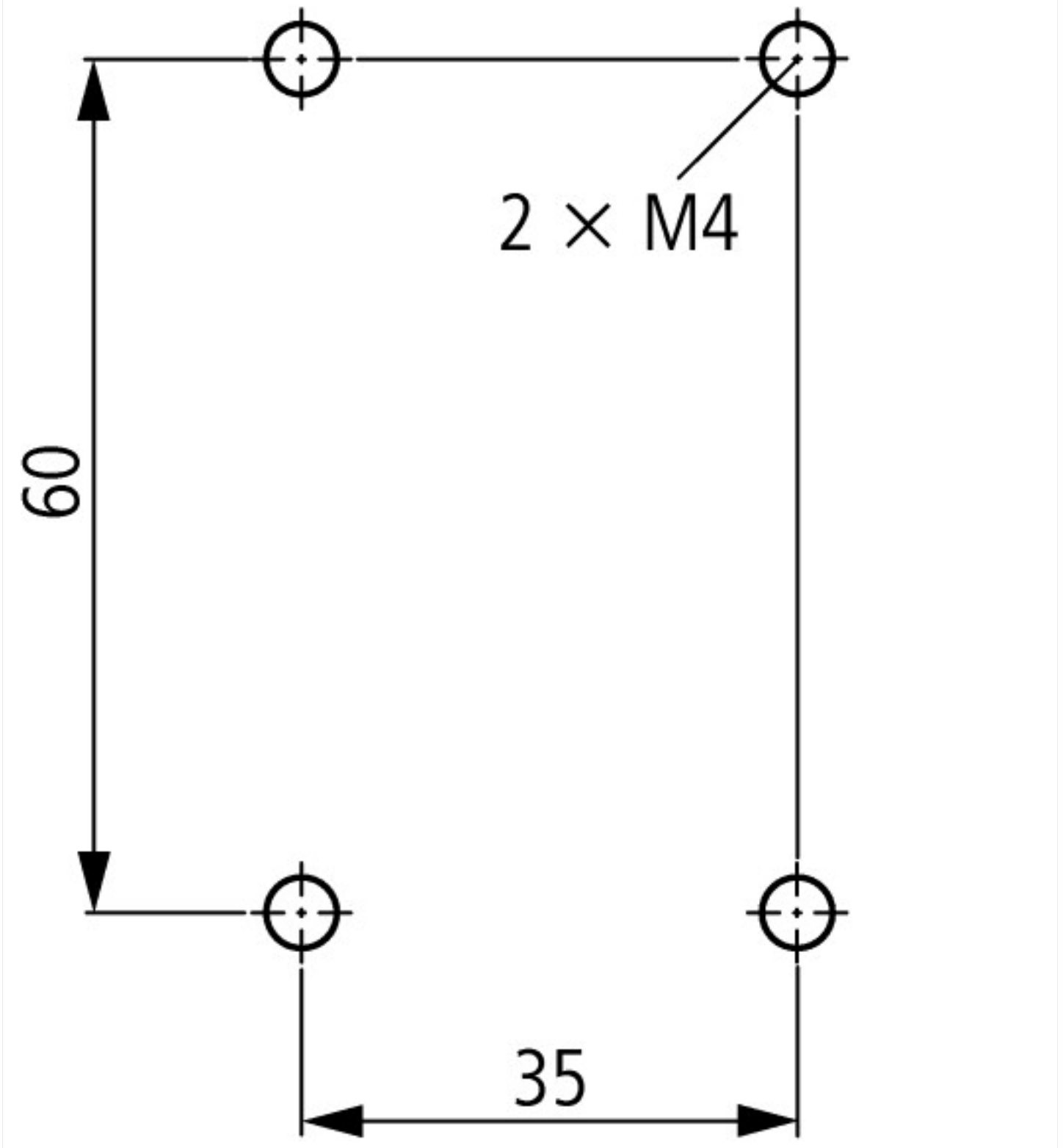

Additional product information (links)

IL03407013Z (AWA2100-2126) Contactors

IL03407013Z (AWA2100-2126) Contactors ftp://ftp.moeller.net/DOCUMENTATION/AWA_INSTRUCTIONS/IL03407013Z2012_03.pdf

UL/CSA: Approved rating data <http://de.ecat.moeller.net/flip-cat/?edition=HPLTE&startpage=5.84>