







## Circuit-breaker, 3p, 20A

Part no. **NZMC1-A20**  
 Catalog No. **283293**

Similar to illustration

## Delivery program

|   |                          |    |                             |
|---|--------------------------|----|-----------------------------|
| Product range   |                          |    | Circuit-breaker             |
| Protective function   |                          |    | System and cable protection |
| Standard/Approval   |                          |    | IEC                         |
| Installation type   |                          |    | Fixed                       |
| Release system  |                          |    | Thermomagnetic release      |
| Construction size   |                          |    | NZM1                        |
| Number of poles   |                          |    | 3 pole                      |
| Standard equipment  |                          |    | Box terminal                |
| <b>Switching capacity</b>   |                          |    |                             |
| 400/415 V 50 Hz   | $I_{cu}$                 | kA | 36                          |
| <b>Rated current = rated uninterrupted current</b>                                  |                          |    |                             |
| Rated current = rated uninterrupted current   | $I_n = I_u$              | A  | 20                          |
| <b>Setting range</b>  |                          |    |                             |
| Overload trip   |                          |    |                             |
|   | $I_r$                    | A  | 15 - 20                     |
| <b>Short-circuit releases</b>   |                          |    |                             |
|  |                          |    |                             |
| Non-delayed   | $I_i = I_n \times \dots$ |    | 350 A fixed                 |
|  |                          |    |                             |
| <b>Short-circuit releases</b>   |                          |    |                             |
|  |                          |    |                             |
| min.  |                          | A  | 350                         |

## Technical data

### General

|   |  |      |  |
|---|--|------|--|
| Standards   |  |      | IEC/EN 60947   |
| Protection against direct contact   |  |      | Finger and back of hand proof to VDE 0106 Part 100                             |
| Climatic proofing   |  |      | Damp heat, constant, to IEC 60068-2-78<br>Damp heat, cyclic, to IEC 60068-2-30 |
| <b>Ambient temperature</b>  |  |      |  |
| Ambient temperature, storage  |  | °C   | -40 - +70  |
| Operation   |  | °C   | -25 - +70  |
| Mechanical shock resistance (10 ms half-sinusoidal shock) according to IEC 60068-2-27 |  | g    | 20 (half-sinusoidal shock 20 ms)   |
| <b>Safe isolation to EN 61140</b>   |  |      |  |
| Between auxiliary contacts and main contacts  |  | V AC | 500  |
| between the auxiliary contacts  |  | V AC | 300  |
| Mounting position   |  |      | Vertical and 90° in all directions   |



With XFI earth-fault release:  
 - NZM1, N1, NZM2, N2: vertical and 90° in all directions  
 with plug-in unit  
 - NZM1, N1, NZM2, N2: vertical, 90° right/left  
 with withdrawable unit:  
 - NZM3, N3: vertical, 90° right/left  
 - NZM4, N4: vertical  
 with remote operator:  
 - NZM2, N(S)2, NZM3, N(S)3, NZM4, N(S)4: vertical and 90° in all directions

|  |  |  |
|--|--|--|
| Direction of incoming supply           |  | as required  |
| Degree of protection                   |  |  |
| Device                                 |  | In the operating controls area: IP20 (basic degree of protection)        |
| Enclosures                             |  | With insulating surround: IP40<br>With door coupling rotary handle: IP66 |
| Terminations                           |  | Tunnel terminal: IP10<br>Phase isolator and strip terminal: IP00         |
| Other technical data (sheet catalogue) |  | Temperature dependency, Derating   |

### Circuit-breakers

|   |             |      |       |
|---|-------------|------|-------|
| Rated current = rated uninterrupted current | $I_n = I_u$ | A    | 20    |
| Rated surge voltage invariability           | $U_{imp}$   |      |       |
| Main contacts                               |             | V    | 6000  |
| Auxiliary contacts                          |             | V    | 6000  |
| Rated operational voltage                   | $U_e$       | V AC | 690   |
| Overtoltage category/pollution degree       |             |      | III/3 |
| Rated insulation voltage                    | $U_i$       | V    | 690   |
| Use in unearthed supply systems             |             | V    | ≦ 690 |

### Switching capacity

|   |          |    |   |
|---|----------|----|---|
| Rated short-circuit making capacity             | $I_{cm}$ |    |   |
| 240 V   | $I_{cm}$ | kA | 121   |
| 400/415 V                                       | $I_{cm}$ | kA | 76  |
| 440 V 50/60 Hz                                  | $I_{cm}$ | kA | 63  |
| 525 V 50/60 Hz                                  | $I_{cm}$ | kA | 24  |
| 690 V 50/60 Hz                                  | $I_c$    | kA | 14  |
| Rated short-circuit breaking capacity $I_{cn}$  | $I_{cn}$ |    |   |
| $I_{cu}$ to IEC/EN 60947 test cycle O-t-CO      | $I_{cu}$ | kA |   |
| 240 V 50/60 Hz                                  | $I_{cu}$ | kA | 55  |
| 400/415 V 50/60 Hz                              | $I_{cu}$ | kA | 36  |
| 440 V 50/60 Hz                                  | $I_{cu}$ | kA | 30  |
| 525 V 50/60 Hz                                  | $I_{cu}$ | kA | 12  |
| 690 V 50/60 Hz                                  | $I_{cu}$ | kA | 8   |
| $I_{cs}$ to IEC/EN 60947 test cycle O-t-CO-t-CO | $I_{cs}$ | kA |   |
| 240 V 50/60 Hz                                  | $I_{cs}$ | kA | 55  |
| 400/415 V 50/60 Hz                              | $I_{cs}$ | kA | 36  |
| 440 V 50/60 Hz                                  | $I_{cs}$ | kA | 22.5  |
| 525 V 50/60 Hz                                  | $I_{cs}$ | kA | 6   |
| 690 V 50/60 Hz                                  | $I_{cs}$ | kA | 4   |
|   |          |    | Maximum back-up fuse, if the expected short-circuit currents at the installation location exceed the switching capacity of the circuit-breaker. |
| Utilization category to IEC/EN 60947-2          |          |    | A   |
| Rated making and breaking capacity              |          |    |   |
| Rated operational current                       | $I_e$    | A  |   |
| AC-1  |          |    |   |
| 380 V 400 V                                     | $I_e$    | A  | 20  |
| 415 V   | $I_e$    | A  | 20  |
| 690 V   | $I_e$    | A  | 20  |

|   |                |       |       |
|---|----------------|-------|-------|
| AC--3   |                |       |       |
| 380 V 400 V   | I <sub>e</sub> | A     | 20    |
| 415 V   | I <sub>e</sub> | A     | 20    |
| 660 V 690 V   | I <sub>e</sub> | A     | 20    |
| Lifespan, mechanical(of which max. 50 % trip by shunt/undervoltage release) | Operations     |       | 20000 |
| Lifespan, electrical  |                |       |       |
| AC-1  |                |       |       |
| 400 V 50/60 Hz  | Operations     |       | 10000 |
| 415 V 50/60 Hz  | Operations     |       | 10000 |
| 690 V 50/60 Hz  | Operations     |       | 5000  |
| AC--3   |                |       |       |
| 415 V 50/60 Hz  | Operations     |       | 7500  |
| Max. operating frequency  |                | Ops/h | 120   |
| Total downtime in a short-circuit   |                | ms    | < 10  |

### Terminal capacity

|   |      |                 |  |
|---|------|-----------------|--|
| Standard equipment  |      |                 | Box terminal   |
| Optional accessories                                      |      |                 | Screw connection<br>Tunnel terminal<br>connection on rear                                    |
| Round copper conductor                                    |      |                 |  |
| Box terminal  |      |                 |  |
| Solid   |      | mm <sup>2</sup> | 1 x (10 - 16)<br>2 x (6 - 16)  |
| Stranded  |      | mm <sup>2</sup> | 1 x (10 - 70) <sup>3)</sup><br>2 x (6-25)  |
|   |      |                 | <sup>3)</sup> Up to 95 mm <sup>2</sup> can be connected depending on the cable manufacturer. |
| Tunnel terminal   |      |                 |  |
| Solid   |      | mm <sup>2</sup> | 1 x 16   |
| Stranded  |      | mm <sup>2</sup> |  |
| 1-hole  |      | mm <sup>2</sup> | 1 x (25 - 95)  |
| Bolt terminal and rear-side connection                    |      |                 |  |
| Direct on the switch                                      |      |                 |  |
| Solid   |      | mm <sup>2</sup> | 1 x (10 - 16)<br>2 x (6 - 16)  |
| Stranded  |      | mm <sup>2</sup> | 1 x (10 - 70) <sup>3)</sup><br>2 x 25  |
|   |      |                 | <sup>3)</sup> Up to 95 mm <sup>2</sup> can be connected depending on the cable manufacturer. |
| Al conductors, Cu cable                                   |      |                 |  |
| Solid   |      | mm <sup>2</sup> | 1 x 16   |
| Stranded  |      | mm <sup>2</sup> |  |
| Stranded  |      | mm <sup>2</sup> | 1 x (25 - 95)  |
| Cu strip (number of segments x width x segment thickness) |      |                 |  |
| Box terminal  |      |                 |  |
|   | min. | mm              | 2 x 9 x 0.8  |
|   | max. | mm              | 9 x 9 x 0.8  |
| Copper busbar (width x thickness)                         | mm   |                 |  |
| Bolt terminal and rear-side connection                    |      |                 |  |
| Screw connection  |      |                 | M6   |
| Direct on the switch                                      |      |                 |  |
|   | min. | mm              | 12 x 5   |
|   | max. | mm              | 16 x 5   |
| Control cables  |      |                 |  |
|   |      | mm <sup>2</sup> | 1 x (0.75 - 2.5)<br>2 x (0.75 - 1.5)   |

## Design verification as per IEC/EN 61439

| Technical data for design verification   |           |    |  |
|--|-----------|----|--|
| Rated operational current for specified heat dissipation   | $I_n$     | A  | 20   |
| Equipment heat dissipation, current-dependent  | $P_{vid}$ | W  | 9.82   |
| Operating ambient temperature max.   |           | °C | -25  |
| Operating ambient temperature max.   |           | °C | 70   |
| IEC/EN 61439 design verification   |           |    |  |
| 10.2 Strength of materials and parts   |           |    |  |
| 10.2.2 Corrosion resistance  |           |    | Meets the product standard's requirements.   |
| 10.2.3.1 Verification of thermal stability of enclosures   |           |    | Meets the product standard's requirements.   |
| 10.2.3.2 Verification of resistance of insulating materials to normal heat   |           |    | Meets the product standard's requirements.   |
| 10.2.3.3 Verification of resistance of insulating materials to abnormal heat and fire due to internal electric effects |           |    | Meets the product standard's requirements.   |
| 10.2.4 Resistance to ultra-violet (UV) radiation   |           |    | Meets the product standard's requirements.   |
| 10.2.5 Lifting   |           |    | Does not apply, since the entire switchgear needs to be evaluated.   |
| 10.2.6 Mechanical impact   |           |    | Does not apply, since the entire switchgear needs to be evaluated.   |
| 10.2.7 Inscriptions  |           |    | Meets the product standard's requirements.   |
| 10.3 Degree of protection of ASSEMBLIES  |           |    | Does not apply, since the entire switchgear needs to be evaluated.   |
| 10.4 Clearances and creepage distances   |           |    | Meets the product standard's requirements.   |
| 10.5 Protection against electric shock   |           |    | Does not apply, since the entire switchgear needs to be evaluated.   |
| 10.6 Incorporation of switching devices and components   |           |    | Does not apply, since the entire switchgear needs to be evaluated.   |
| 10.7 Internal electrical circuits and connections  |           |    | Is the panel builder's responsibility.   |
| 10.8 Connections for external conductors   |           |    | Is the panel builder's responsibility.   |
| 10.9 Insulation properties   |           |    |  |
| 10.9.2 Power-frequency electric strength   |           |    | Is the panel builder's responsibility.   |
| 10.9.3 Impulse withstand voltage   |           |    | Is the panel builder's responsibility.   |
| 10.9.4 Testing of enclosures made of insulating material   |           |    | Is the panel builder's responsibility.   |
| 10.10 Temperature rise   |           |    | The panel builder is responsible for the temperature rise calculation. Eaton will provide heat dissipation data for the devices. |
| 10.11 Short-circuit rating   |           |    | Is the panel builder's responsibility. The specifications for the switchgear must be observed.                                   |
| 10.12 Electromagnetic compatibility  |           |    | Is the panel builder's responsibility. The specifications for the switchgear must be observed.                                   |
| 10.13 Mechanical function  |           |    | The device meets the requirements, provided the information in the instruction leaflet (IL) is observed.                         |

## Technical data ETIM 6.0

| Low-voltage industrial components (EG000017) / Power circuit-breaker for trafo/generator/installation prot. (EC000228)   |  |    |  |
|--|--|----|--|
| Electric engineering, automation, process control engineering / Low-voltage switch technology / Circuit breaker (LV < 1 kV) / Circuit breaker for power transformer, generator and system protection (ecl@ss8.1-27-37-04-09 [AJZ716010]) |  |    |  |
| Rated permanent current $I_u$  |  | A  | 20                                       |
| Rated voltage  |  | V  | 690 - 690                                |
| Rated short-circuit breaking capacity $I_{cu}$ at 400 V, 50 Hz   |  | kA | 36                                       |
| Overload release current setting   |  | A  | 15 - 20                                  |
| Adjustment range short-term delayed short-circuit release  |  | A  | 0 - 0                                    |
| Adjustment range undelayed short-circuit release   |  | A  | 350 - 350                                |
| Integrated earth fault protection  |  |    | No                                       |
| Type of electrical connection of main circuit  |  |    | Frame clamp                              |
| Device construction  |  |    | Built-in device fixed built-in technique |
| Suitable for DIN rail (top hat rail) mounting  |  |    | No                                       |
| DIN rail (top hat rail) mounting optional  |  |    | Yes                                      |
| Number of auxiliary contacts as normally closed contact  |  |    | 0  |
| Number of auxiliary contacts as normally open contact  |  |    | 0  |
| Number of auxiliary contacts as change-over contact  |  |    | 0  |
| Switched-off indicator available   |  |    | No                                       |
| With under voltage release   |  |    | No                                       |
| Number of poles  |  |    | 3  |

|   |  |              |
|---|--|--------------|
| Position of connection for main current circuit |  | Front side   |
| Type of control element                         |  | Rocker lever |
| Complete device with protection unit            |  | Yes          |
| Motor drive integrated                          |  | No           |
| Motor drive optional                            |  | No           |
| Degree of protection (IP)                       |  | IP20         |

## Characteristics

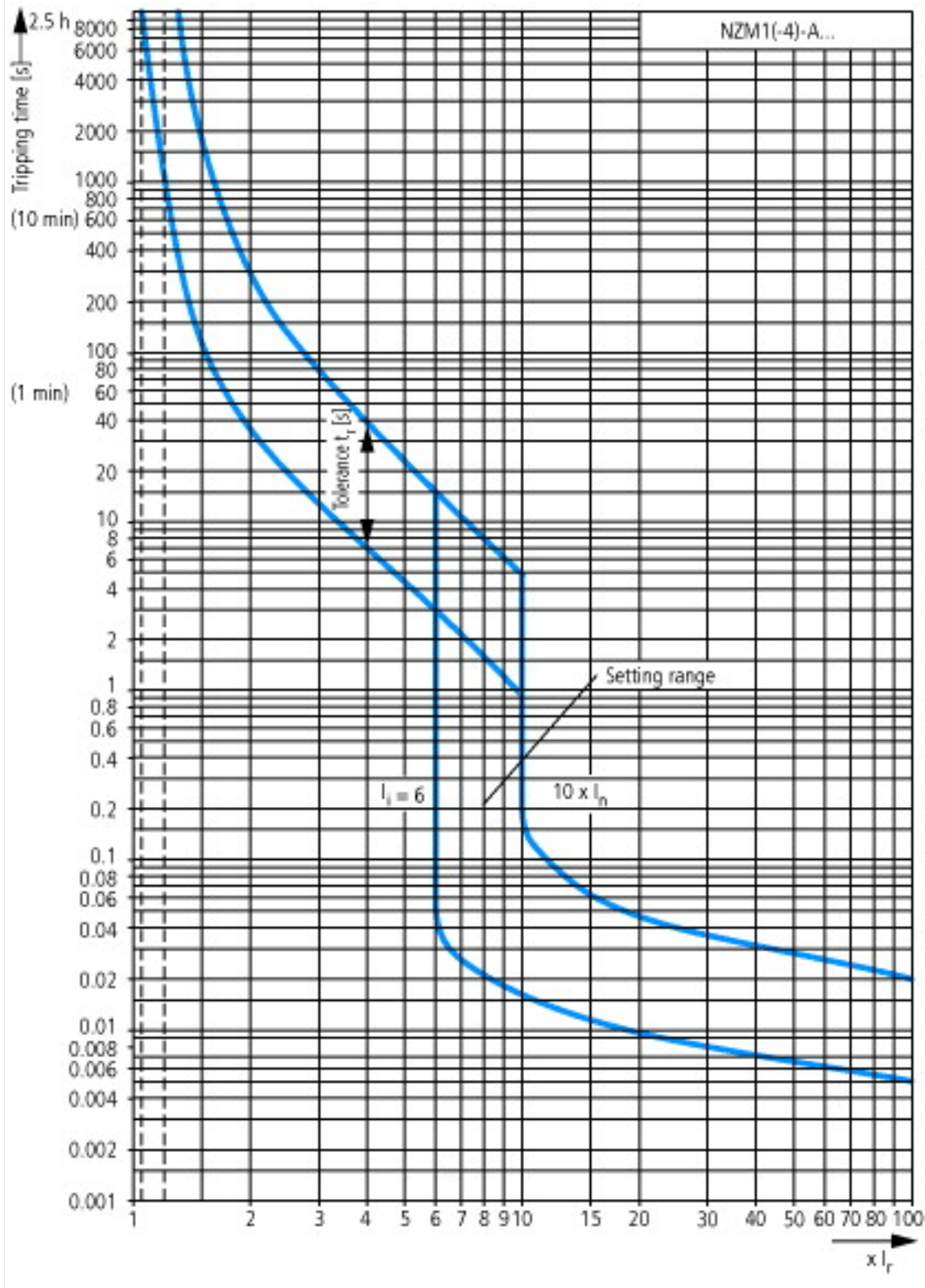

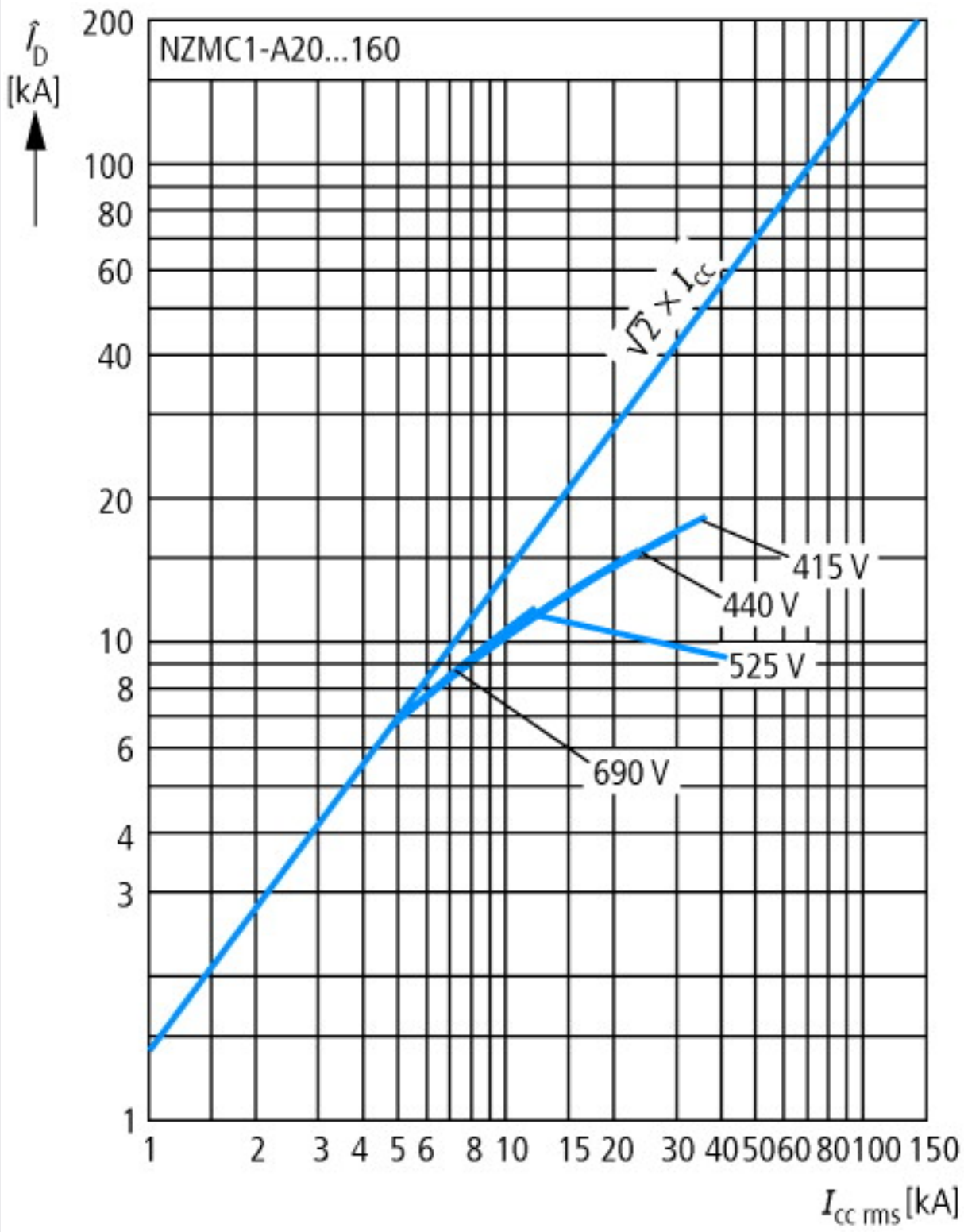

Let-through current



Let-through energy

## Dimensions

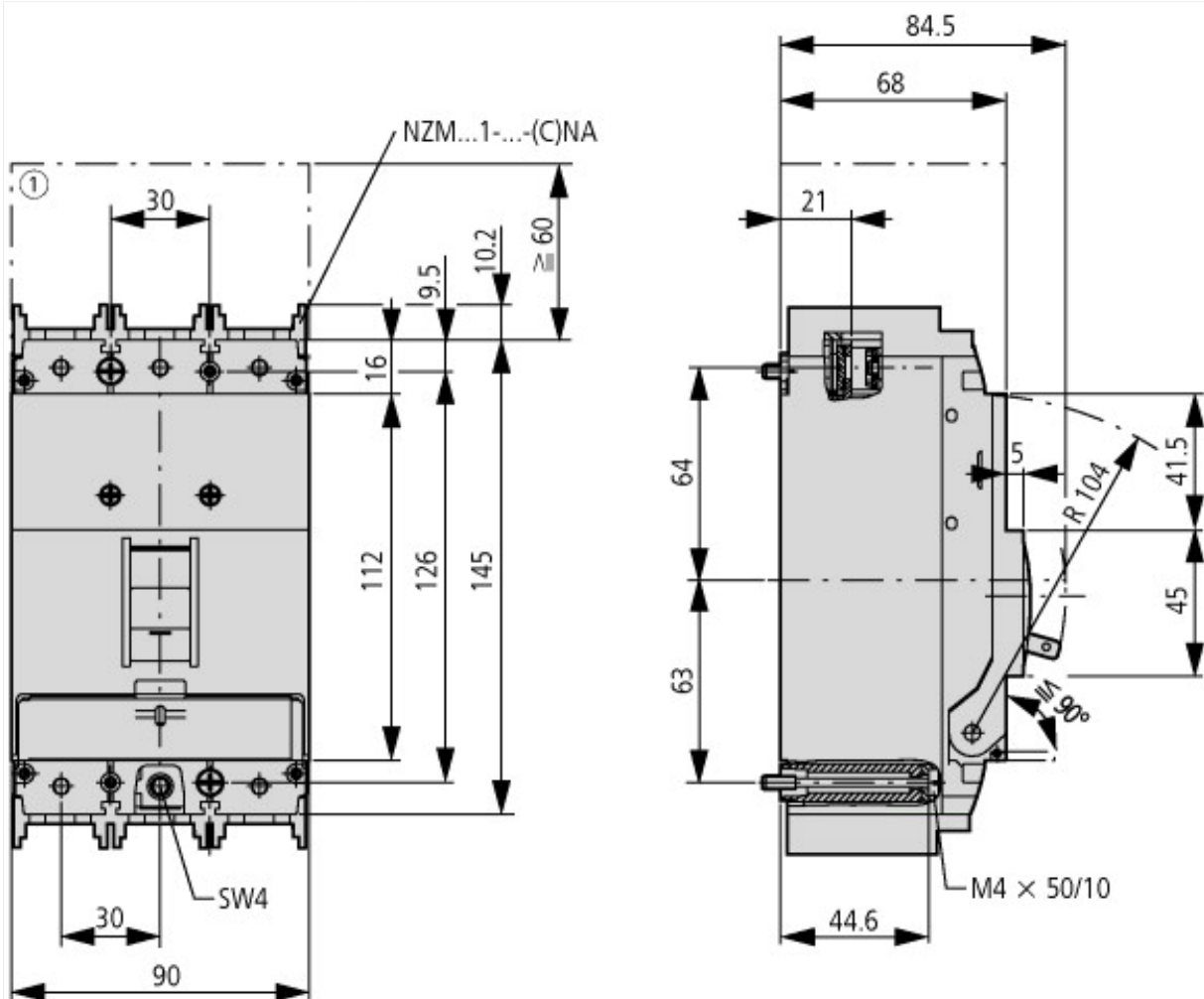

① Blow out area, minimum clearance to adjacent parts



### Additional product information (links)

#### IL01203004Z (AWA1230-1913) Circuit-breaker, Switch-Disconnecter

IL01203004Z (AWA1230-1913) Circuit-breaker, Switch-Disconnecter

[ftp://ftp.moeller.net/DOCUMENTATION/AWA\\_INSTRUCTIONS/IL01203004Z2015\\_11.pdf](ftp://ftp.moeller.net/DOCUMENTATION/AWA_INSTRUCTIONS/IL01203004Z2015_11.pdf)

Temperature dependency, Derating

<http://ecat.moeller.net/flip-cat/?edition=HPLEN&startpage=17.172>

CurveSelect characteristics program

<http://www.eaton.eu/DE/Europe/Electrical/CustomerSupport/ConfigurationTools/CharacteristicsProgram/index.htm>