



**Contactor, 3p+1N/O, 7.5kW/400V/AC3**

**Part no. DILM15-10(24VDC)**  
**Catalog No. 290073**  
**Eaton Catalog No. XTCE015B10TD**  
**EL-Nummer 4110368**  
**(Norway)**

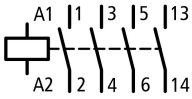

## Delivery program

Product range			Contactors
Application			Contactors for Motors
Subrange			Contactors up to 170 A, 3 pole
Utilization category			AC-1: Non-inductive or slightly inductive loads, resistance furnaces AC-3: Normal AC induction motors: starting, switch off during running AC-4: Normal AC induction motors: starting, plugging, reversing, inching
Notes			Not suitable for motors with efficiency class IE3.
Connection technique			Screw terminals
Number of poles			3 pole
<b>Rated operational current</b>			
AC-3			
380 V 400 V	$I_e$	A	15.5
AC-1			
Conventional free air thermal current, 3 pole, 50 - 60 Hz			
Open			
at 40 °C	$I_{th} = I_e$	A	22
enclosed	$I_{th}$	A	18
Conventional free air thermal current, 1 pole			
open	$I_{th}$	A	50
enclosed	$I_{th}$	A	45
<b>Max. rating for three-phase motors, 50 - 60 Hz</b>			
AC-3			
220 V 230 V	P	kW	4
380 V 400 V	P	kW	7.5
660 V 690 V	P	kW	7
AC-4			
220 V 230 V	P	kW	2
380 V 400 V	P	kW	3
660 V 690 V	P	kW	4.4
<b>Contacts</b>			
N/O = Normally open			1 N/O
Contact sequence			
<b>Instructions</b>			
Can be combined with auxiliary contact			DILM32-XHI.. DILA-XHI(V)..
Voltage AC/DC			DC operation

## Technical data

<b>General</b>			
Standards			IEC/EN 60947, VDE 0660, UL, CSA
Lifespan, mechanical			
DC operated	Operations	$\times 10^6$	10
Operating frequency, mechanical			
DC operated	Operations/h		5000
Climatic proofing			Damp heat, constant, to IEC 60068-2-78

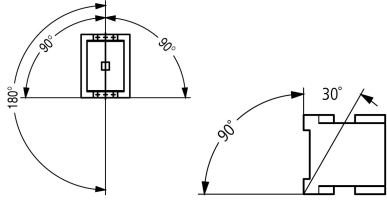
			Damp heat, cyclic, to IEC 60068-2-30
<b>Ambient temperature</b>			
Open	°C		-25 - +60
Enclosed	°C		- 25 - 40
Storage	°C		- 40 - 80
<b>Mounting position</b>			
			
<b>Mechanical shock resistance (IEC/EN 60068-2-27)</b>			
Half-sinusoidal shock, 10 ms			
Main contacts			
N/O contact	g		10
Auxiliary contacts			
N/O contact	g		7
N/C contact	g		5
<b>Mechanical shock resistance (IEC/EN 60068-2-27) when tabletop-mounted</b>			
Half-sinusoidal shock, 10 ms			
Main contacts			
N/O contact	g		5.7
Auxiliary contacts			
N/O contact	g		3.4
N/C contact	g		3.4
<b>Degree of Protection</b>			
			IP20
<b>Protection against direct contact when actuated from front (EN 50274)</b>			Finger and back-of-hand proof
<b>Weight</b>			
DC operated	kg		0.296
<b>Terminal capacity main cable</b>			
Solid	mm <sup>2</sup>		1 x (0.75 - 4) 2 x (0.75 - 2.5)
Flexible with ferrule	mm <sup>2</sup>		1 x (0.75 - 2.5) 2 x (0.75 - 2.5)
			Also without ferrule.
Solid or stranded	AWG		single 18 - 10, double 18 - 14
Stripping length	mm		10
Main cable connection screw/bolt			M3.5
Tightening torque	Nm		999999999 1.2
<b>Terminal capacity control circuit cables</b>			
Solid	mm <sup>2</sup>		1 x (0.75 - 4) 2 x (0.75 - 2.5)
Flexible with ferrule	mm <sup>2</sup>		1 x (0.75 - 2.5) 2 x (0.75 - 2.5)
Solid or stranded	AWG		18 - 14
Stripping length	mm		10
Control circuit cable connection screw/bolt			M3.5
Tightening torque	Nm		1.2
<b>Tool</b>			
Main cable			
Pozidriv screwdriver	Size		2
Standard screwdriver	mm		0.8 x 5.5 1 x 6
Control circuit cables			
Pozidriv screwdriver	Size		2
Standard screwdriver	mm		0.8 x 5.5 1 x 6

## Main conducting paths

Rated impulse withstand voltage	$U_{imp}$	V AC	8000
Overtoltage category/pollution degree			III/3
Rated insulation voltage	$U_i$	V AC	690
Rated operational voltage	$U_e$	V AC	690
Safe isolation to EN 61140			
between coil and contacts		V AC	400
between the contacts		V AC	400
Making capacity (p.f. to IEC/EN 60947)			
	$U_p$ to 690 V	A	155
Breaking capacity			
220 V 230 V		A	124
380 V 400 V		A	124
500 V		A	100
660 V 690 V		A	70
Short-circuit rating			
Short-circuit protection maximum fuse			
Type "2" coordination			
400 V	gG/gL 500 V	A	20
690 V	gG/gL 690 V	A	20
Type "1" coordination			
400 V	gG/gL 500 V	A	63
690 V	gG/gL 690 V	A	50

## AC

AC-1			
Rated operational current			
Conventional free air thermal current, 3 pole, 50 - 60 Hz			
Open			
at 40 °C	$I_{th} = I_e$	A	22
at 50 °C	$I_{th} = I_e$	A	21
at 55 °C	$I_{th} = I_e$	A	21
at 60 °C	$I_{th} = I_e$	A	20
enclosed	$I_{th}$	A	18
Conventional free air thermal current, 1 pole			
open	$I_{th}$	A	50
enclosed	$I_{th}$	A	45
AC-3			
Rated operational current			
Open, 3-pole: 50 – 60 Hz			
220 V 230 V	$I_e$	A	15.5
240 V	$I_e$	A	15.5
380 V 400 V	$I_e$	A	15.5
415 V	$I_e$	A	15.5
440V	$I_e$	A	15.5
500 V	$I_e$	A	12.5
660 V 690 V	$I_e$	A	9
380 V 400 V	$I_e$	A	15.5
Motor rating	P	kWh	
220 V 230 V	P	kW	4
240V	P	kW	4.6
380 V 400 V	P	kW	7.5
415 V	P	kW	8
440 V	P	kW	8.4
500 V	P	kW	7.5

660 V 690 V	P	kW	7
<b>AC-4</b>			
Open, 3-pole: 50 – 60 Hz			
220 V 230 V	$I_e$	A	7
240 V	$I_e$	A	7
380 V 400 V	$I_e$	A	7
415 V	$I_e$	A	7
440 V	$I_e$	A	7
500 V	$I_e$	A	6
660 V 690 V	$I_e$	A	5
Motor rating			
220 V 230 V	P	kW	2
240 V	P	kW	2.2
380 V 400 V	P	kW	3
415 V	P	kW	3.4
440 V	P	kW	3.6
500 V	P	kW	3.5
660 V 690 V	P	kW	4.4

## DC

Rated operational current, open			
<b>DC-1</b>			
60 V	$I_e$	A	20
110 V	$I_e$	A	20
220 V	$I_e$	A	15

## Current heat loss

3 pole, at $I_{th}$ (60°)		W	4
Current heat loss at $I_e$ to AC-3/400 V		W	2.4
Impedance per pole		mΩ	4.6

## Magnet systems

Voltage tolerance			
DC operated	Pick-up	$x U_c$	0.8 - 1.1
Notes			0.85 - 1.1 only with auxiliary contact module with 3 or more N/C contacts 0.7 – 1.3 without auxiliary contact module and at ambient air temperature + +40 °C
DC operated	Drop-out	$x U_c$	0.15 - 0.6
Notes			at least smoothed two-phase bridge rectifier or three-phase rectifier
Power consumption of the coil in a cold state and $1.0 x U_c$			
50/60 Hz	Pick-up	VA	0
50/60 Hz	Sealing	VA	0
DC operated	Pick-up	W	4.5
DC operated	Sealing	W	2.6
Duty factor		% DF	100
Changeover time at 100 % $U_c$ (recommended value)			
Main contacts			
DC operated		ms	
Closing delay		ms	31
Opening delay		ms	12
Arcing time		ms	999999999 10

## Electromagnetic compatibility (EMC)

Emitted interference			nach EN 60947-1
Interference immunity			nach EN 60947-1

## Rating data for approved types

Switching capacity			
Maximum motor rating			
Three-phase			
200 V		HP	5

208 V		
230 V 240 V	HP	5
460 V 480 V	HP	10
575 V 600 V	HP	10
Single-phase		
115 V 120 V	HP	1
230 V 240 V	HP	3
General use	A	20
<b>Auxiliary contacts</b>		
<b>Pilot Duty</b>		
AC operated		A600
DC operated		P300
<b>General Use</b>		
AC	V	600
AC	A	10
DC	V	250
DC	A	1
<b>Short Circuit Current Rating</b>	SCCR	
<b>Basic Rating</b>		
SCCR	kA	5
max. Fuse	A	45
max. CB	A	60
<b>480 V High Fault</b>		
SCCR (fuse)	kA	30/100
max. Fuse	A	25 Class RK5/60 Class J
<b>600 V High Fault</b>		
SCCR (fuse)	kA	30/100
max. Fuse	A	25 Class RK5/60 Class J
<b>Special Purpose Ratings</b>		
<b>Electrical Discharge Lamps (Ballast)</b>		
480V 60Hz 3phase, 277V 60Hz 1phase	A	20
600V 60Hz 3phase, 347V 60Hz 1phase	A	20
<b>Incandescent Lamps (Tungsten)</b>		
480V 60Hz 3phase, 277V 60Hz 1phase	A	14
600V 60Hz 3phase, 347V 60Hz 1phase	A	14
<b>Resistance Air Heating</b>		
480V 60Hz 3phase, 277V 60Hz 1phase	A	20
600V 60Hz 3phase, 347V 60Hz 1phase	A	20
<b>Refrigeration Control (CSA only)</b>		
LRA 480V 60Hz 3phase	A	60
FLA 480V 60Hz 3phase	A	10
LRA 600V 60Hz 3phase	A	60
FLA 600V 60Hz 3phase	A	10
<b>Definite Purpose Ratings (100,000 cycles acc. to UL 1995)</b>		
LRA 480V 60Hz 3phase	A	90
FLA 480V 60Hz 3phase	A	15
<b>Elevator Control</b>		
200V 60Hz 3phase	HP	2
200V 60Hz 3phase	A	7.8
240V 60Hz 3phase	HP	3
240V 60Hz 3phase	A	9.6
480V 60Hz 3phase	HP	7.5

480V 60Hz 3phase	A	11
600V 60Hz 3phase	HP	7.5
600V 60Hz 3phase	A	9

## Design verification as per IEC/EN 61439

Technical data for design verification			
Rated operational current for specified heat dissipation	$I_n$	A	15.5
Heat dissipation per pole, current-dependent	$P_{vid}$	W	0.8
Equipment heat dissipation, current-dependent	$P_{vid}$	W	0
Static heat dissipation, non-current-dependent	$P_{vs}$	W	2.6
Heat dissipation capacity	$P_{diss}$	W	0
Operating ambient temperature max.		°C	-25
Operating ambient temperature max.		°C	60
IEC/EN 61439 design verification			
10.2 Strength of materials and parts			
10.2.2 Corrosion resistance			Meets the product standard's requirements.
10.2.3 Verification of thermal stability of enclosures			
10.2.3.1 Verification of thermal stability of enclosures			Meets the product standard's requirements.
10.2.3.2 Verification of resistance of insulating materials to normal heat			
10.2.3.2 Verification of resistance of insulating materials to normal heat			Meets the product standard's requirements.
10.2.3.3 Verification of resistance of insulating materials to abnormal heat and fire due to internal electric effects			
10.2.3.3 Verification of resistance of insulating materials to abnormal heat and fire due to internal electric effects			Meets the product standard's requirements.
10.2.4 Resistance to ultra-violet (UV) radiation			Meets the product standard's requirements.
10.2.5 Lifting			Does not apply, since the entire switchgear needs to be evaluated.
10.2.6 Mechanical impact			Does not apply, since the entire switchgear needs to be evaluated.
10.2.7 Inscriptions			Meets the product standard's requirements.
10.3 Degree of protection of ASSEMBLIES			Does not apply, since the entire switchgear needs to be evaluated.
10.4 Clearances and creepage distances			Meets the product standard's requirements.
10.5 Protection against electric shock			Does not apply, since the entire switchgear needs to be evaluated.
10.6 Incorporation of switching devices and components			Does not apply, since the entire switchgear needs to be evaluated.
10.7 Internal electrical circuits and connections			Is the panel builder's responsibility.
10.8 Connections for external conductors			Is the panel builder's responsibility.
10.9 Insulation properties			
10.9.2 Power-frequency electric strength			Is the panel builder's responsibility.
10.9.3 Impulse withstand voltage			Is the panel builder's responsibility.
10.9.4 Testing of enclosures made of insulating material			Is the panel builder's responsibility.
10.10 Temperature rise			The panel builder is responsible for the temperature rise calculation. Eaton will provide heat dissipation data for the devices.
10.11 Short-circuit rating			Is the panel builder's responsibility. The specifications for the switchgear must be observed.
10.12 Electromagnetic compatibility			Is the panel builder's responsibility. The specifications for the switchgear must be observed.
10.13 Mechanical function			The device meets the requirements, provided the information in the instruction leaflet (IL) is observed.

## Technical data ETIM 6.0

Low-voltage industrial components (EG000017) / Power contactor, AC switching (EC000066)			
Electric engineering, automation, process control engineering / Low-voltage switch technology / Contactor (LV) / Power contactor, AC switching (ecl@ss8.1-27-37-10-03 [AAB718012])			
Rated control supply voltage $U_s$ at AC 50HZ		V	0 - 0
Rated control supply voltage $U_s$ at AC 60HZ		V	0 - 0
Rated control supply voltage $U_s$ at DC		V	24 - 24
Voltage type for actuating			DC
Rated operation current $I_e$ at AC-1, 400 V		A	22
Rated operation current $I_e$ at AC-3, 400 V		A	15.5
Rated operation power at AC-3, 400 V		kW	7.5
Rated operation current $I_e$ at AC-4, 400 V		A	7
Rated operation power $I_e$ at AC-4, 400 V		kW	3
Modular version			No
Number of auxiliary contacts as normally open contact			1

Number of auxiliary contacts as normally closed contact	0
Type of electrical connection of main circuit	Screw connection
Number of normally closed contacts as main contact	0
Number of main contacts as normally open contact	3

## Approvals

Product Standards	IEC/EN 60947-4-1; UL 60947-4-1; CSA - C22.2 No. 60947-4-1-14; CE marking
UL File No.	E29096
UL Category Control No.	NLDX
CSA File No.	012528
CSA Class No.	2411-03, 3211-04
North America Certification	UL listed, CSA certified
Specially designed for North America	No

## Characteristics

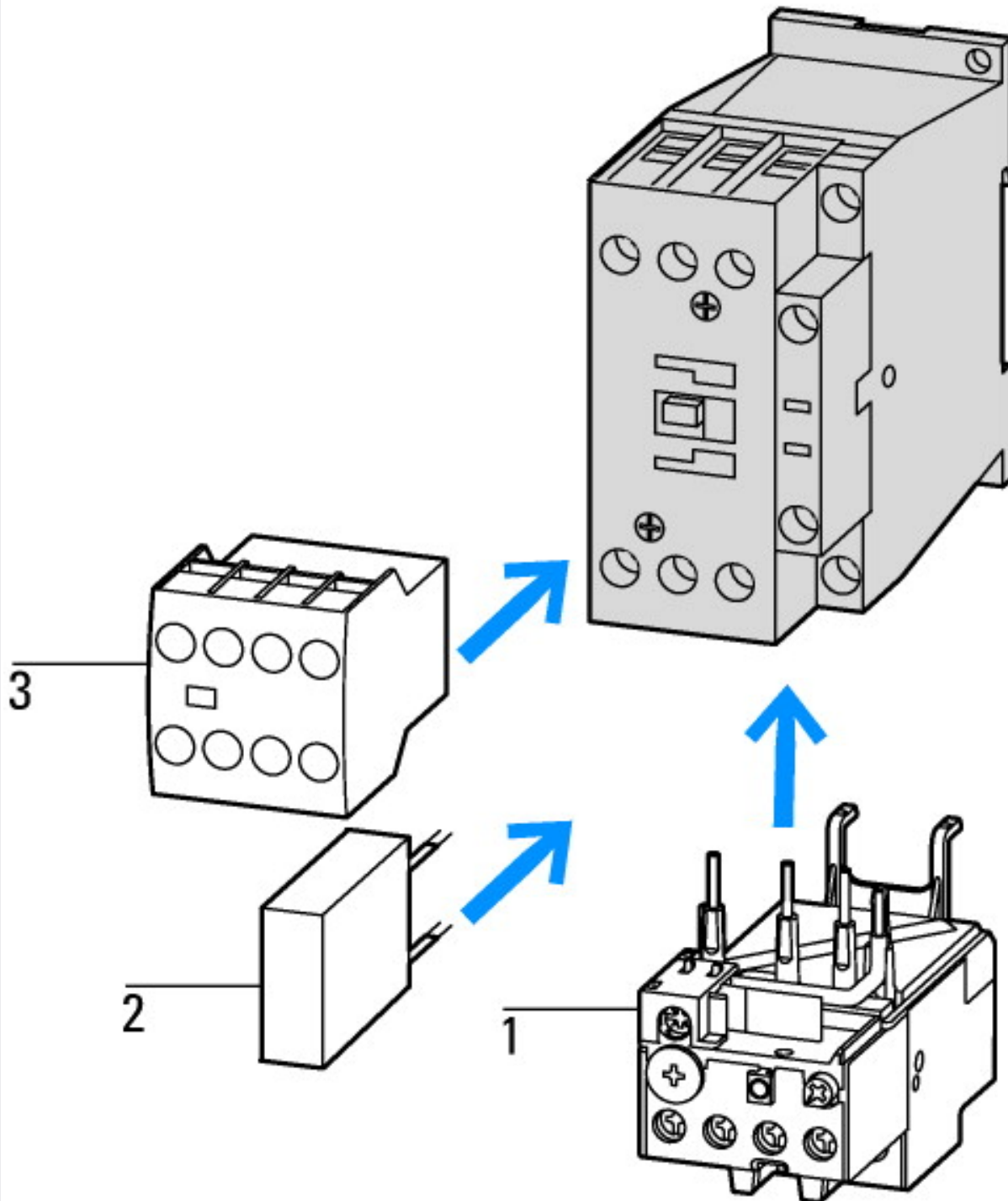

1: Overload relay  
2: Suppressor

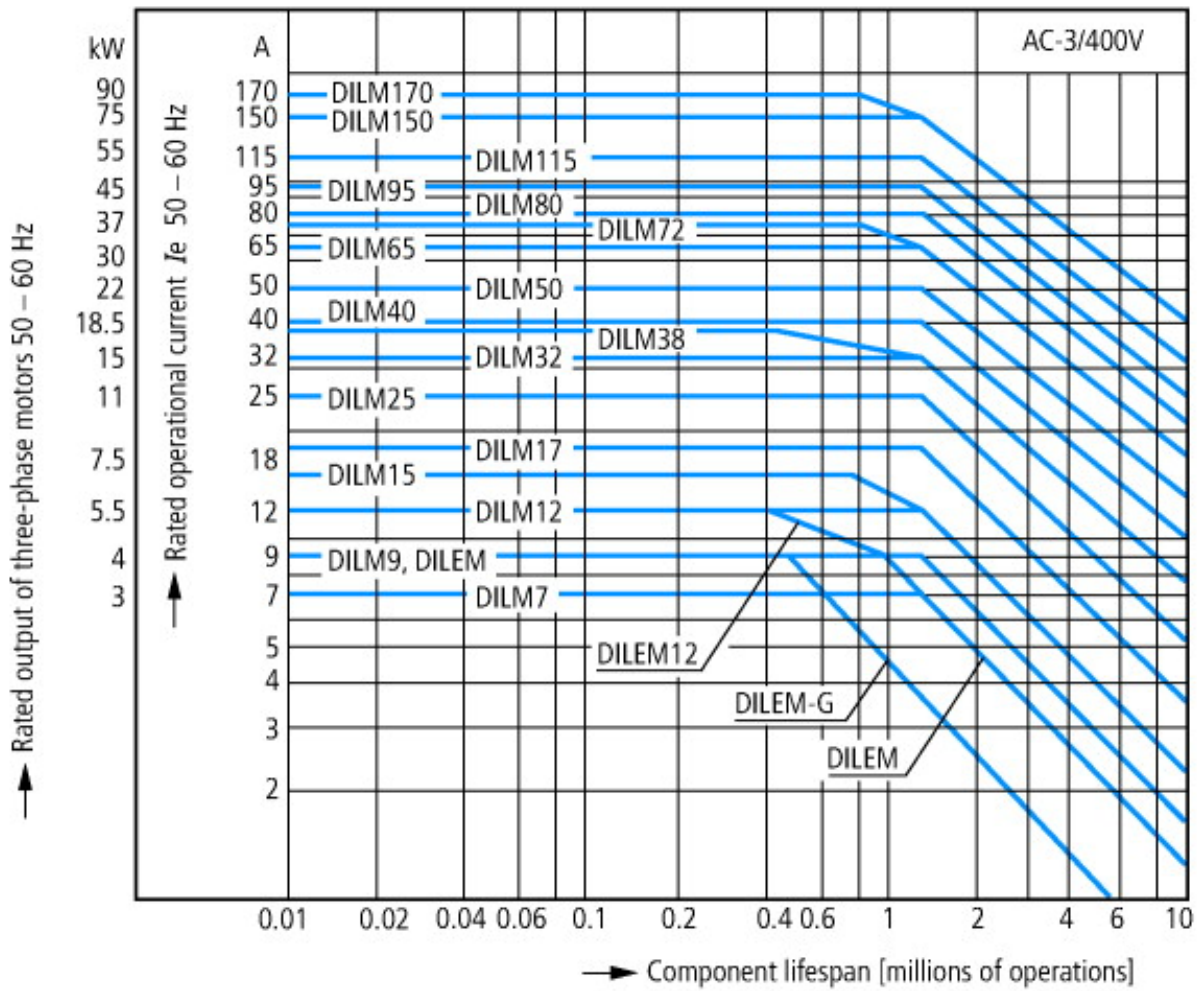

Normal AC induction motor  
 Operating characteristics  
 Switch on: from stop  
 Switch off: during run  
 Electrical characteristics:  
 Switch on: up to 6 x Rated motor current  
 Switch off: up to 1 x Rated motor current  
 Utility category

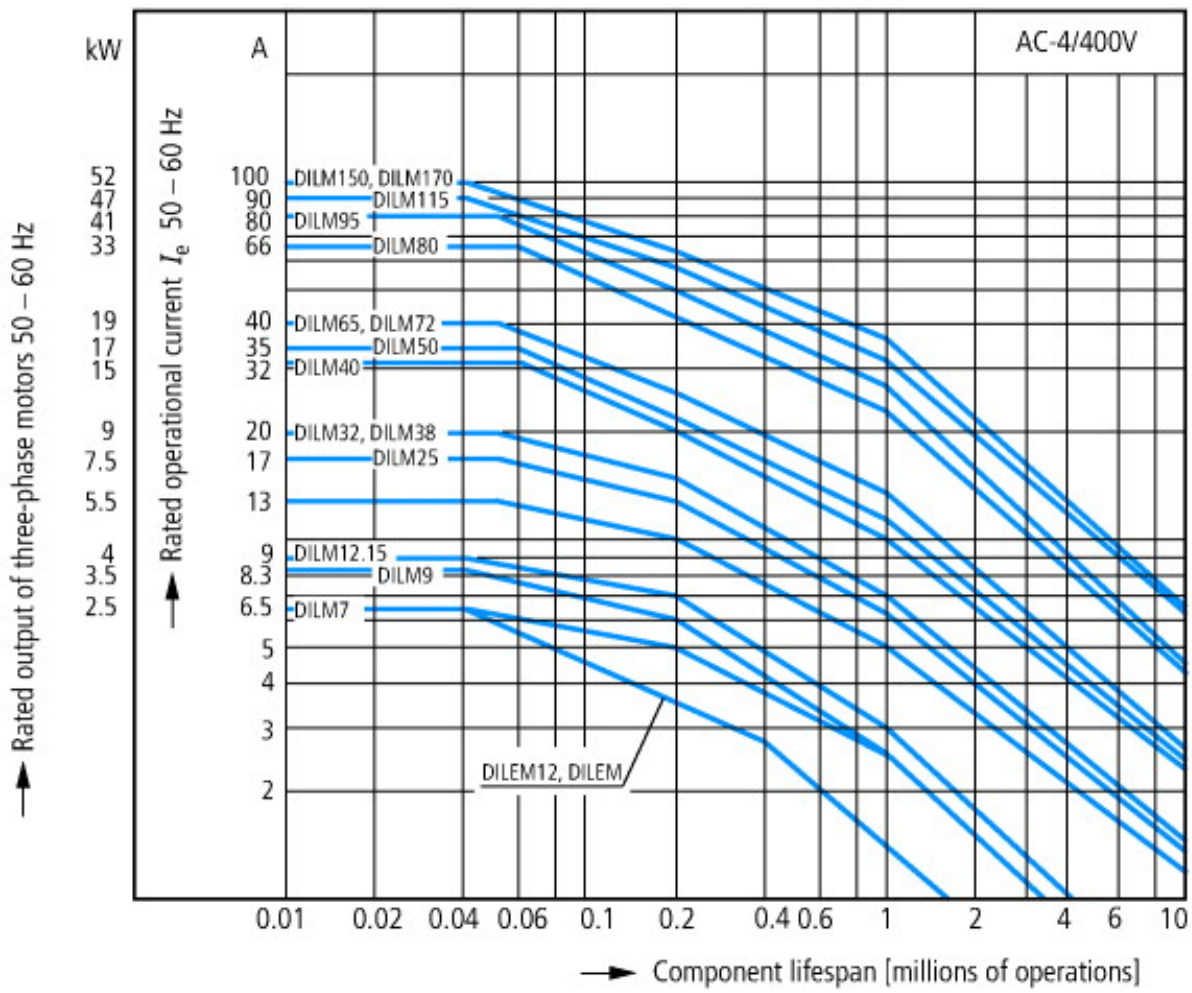

Extreme switching duty  
 Normal AC induction motor  
 Operating characteristics  
 Inching, plugging, reversing  
 Electrical characteristics:  
 Switch on: up to 6 x Rated motor current  
 Switch off: up to 6 x Rated motor current  
 Utilization



Switching conditions for non-motor consumers, 3 pole, 4 pole  
 Operating characteristics  
 Non inductive and slightly inductive loads  
 Electrical characteristics  
 Switch on: 1 x rated operational current  
 Switch off: 1 x rated operational current  
 Utilization category  
 100 % AC-1  
 Typical examples of application  
 Electric heat

## Dimensions

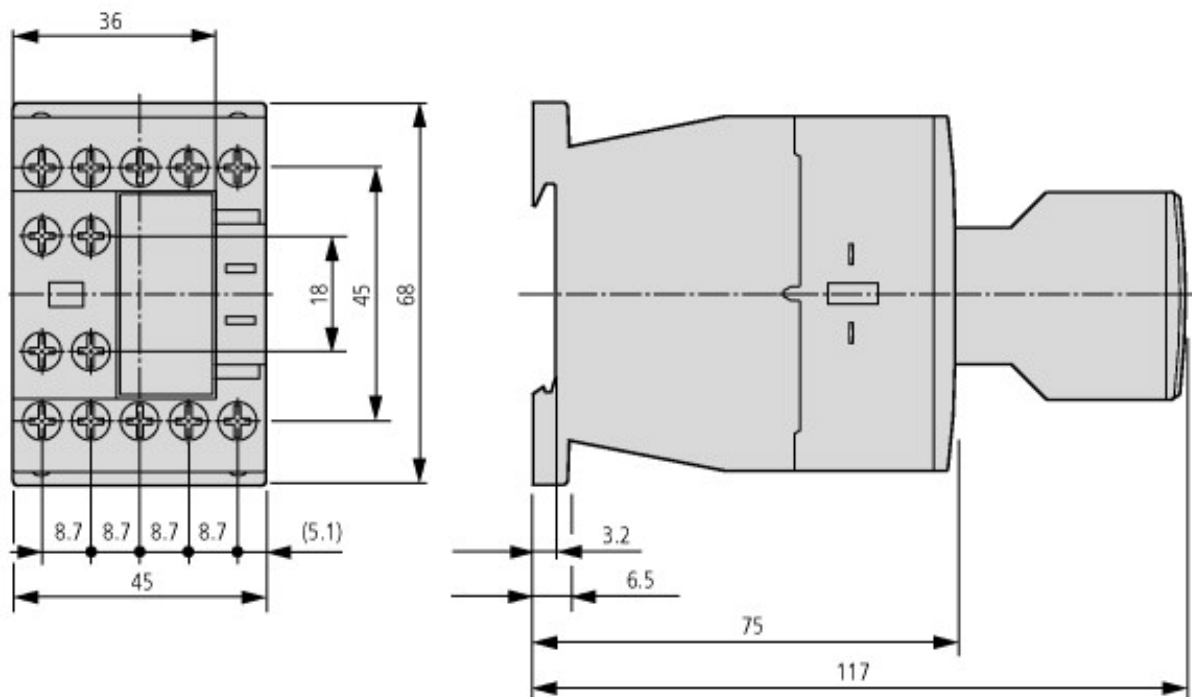

Contactor with auxiliary contact module DILM32-XHI.../DILA-XHI...

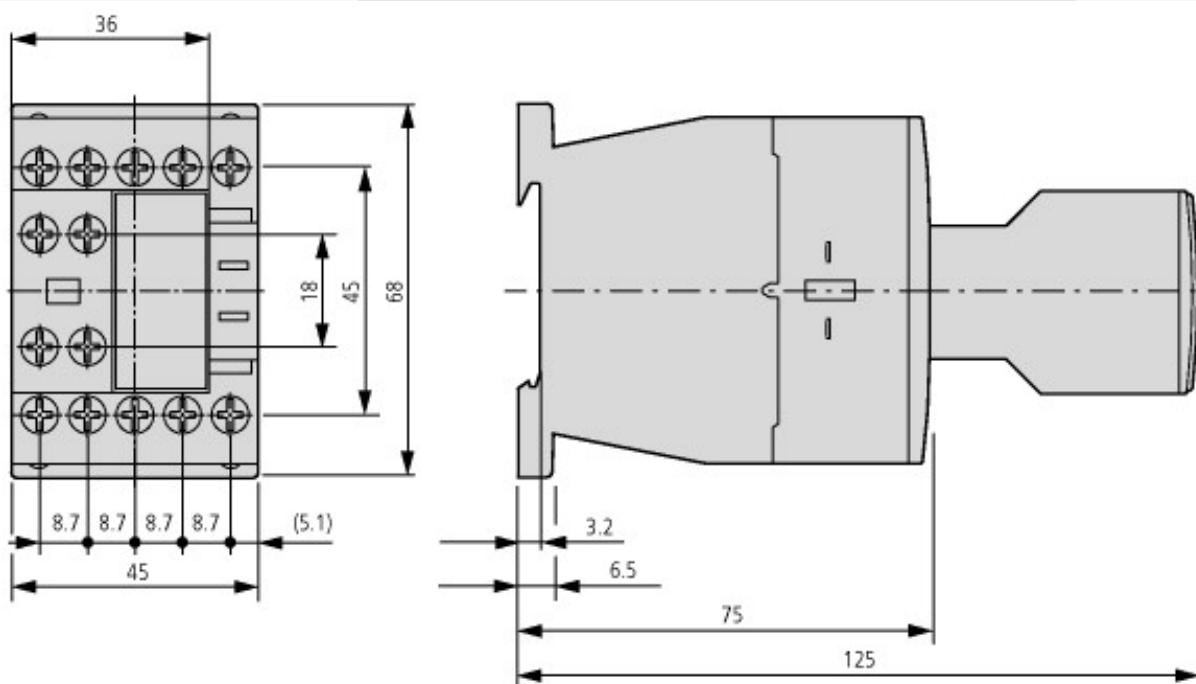

Contactor with auxiliary contact module DILA-XHIT...

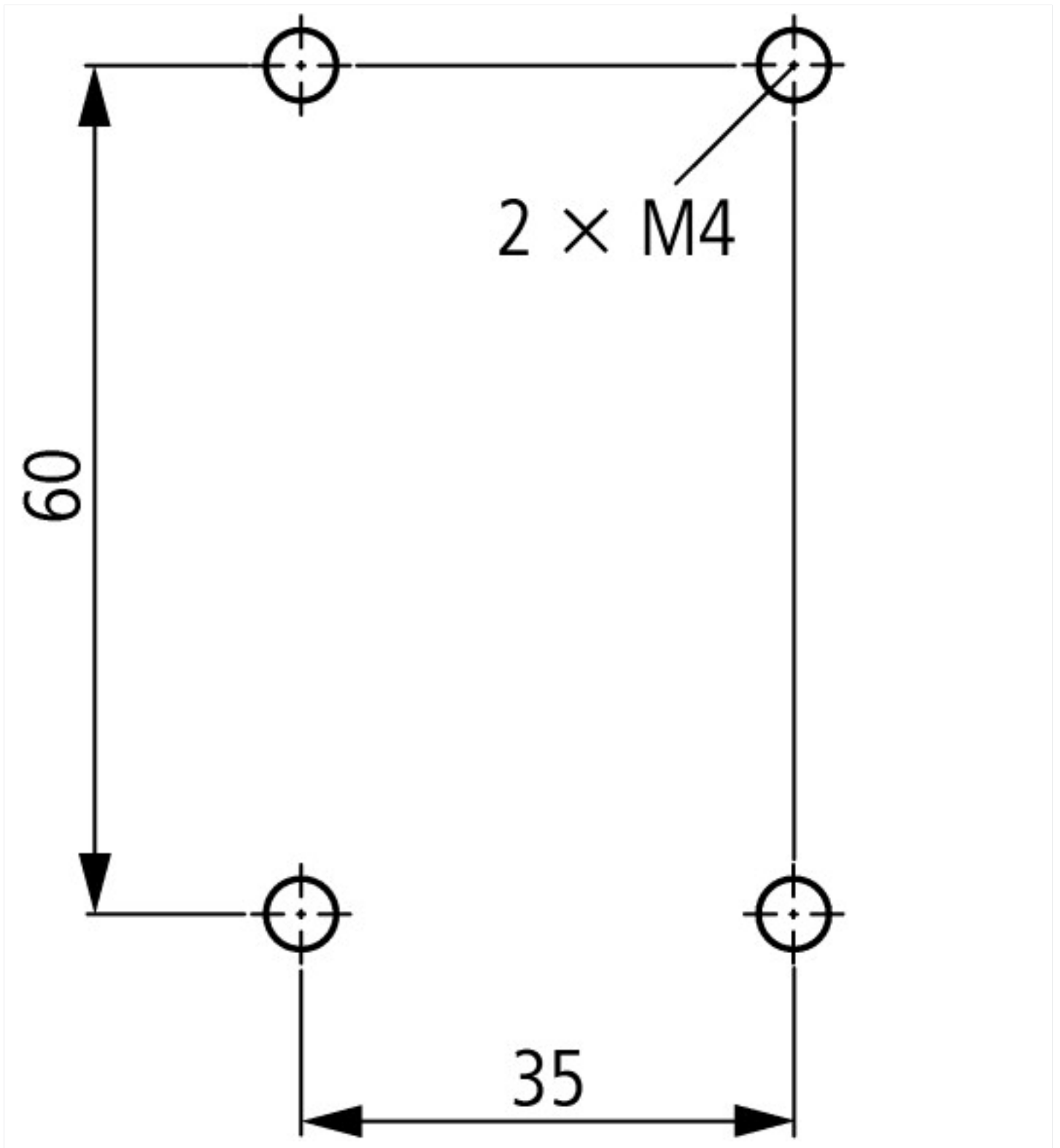

### Additional product information (links)

#### IL03407013Z (AWA2100-2126) Contactors

IL03407013Z (AWA2100-2126) Contactors	<a href="ftp://ftp.moeller.net/DOCUMENTATION/AWA_INSTRUCTIONS/IL03407013Z2012_03.pdf">ftp://ftp.moeller.net/DOCUMENTATION/AWA_INSTRUCTIONS/IL03407013Z2012_03.pdf</a>
UL/CSA: Approved rating data	<a href="http://de.ecat.moeller.net/flip-cat/?edition=HPLTE&amp;startpage=5.84">http://de.ecat.moeller.net/flip-cat/?edition=HPLTE&amp;startpage=5.84</a>
UL/CSA: UL/CSA: Special Purpose Rating	<a href="http://de.ecat.moeller.net/flip-cat/?edition=HPLTE&amp;startpage=5.85">http://de.ecat.moeller.net/flip-cat/?edition=HPLTE&amp;startpage=5.85</a>
UL/CSA: UL/CSA: Short Circuit Current Rating (SCCR)	<a href="http://de.ecat.moeller.net/flip-cat/?edition=HPLTE&amp;startpage=5.86">http://de.ecat.moeller.net/flip-cat/?edition=HPLTE&amp;startpage=5.86</a>
Switchgear of Power Factor Correction Systems	<a href="http://www.moeller.net/binary/ver_techpapers/ver934en.pdf">http://www.moeller.net/binary/ver_techpapers/ver934en.pdf</a>
X-Start - Modern Switching Installations Efficiently Fitted and Wired Securely	<a href="http://www.moeller.net/binary/ver_techpapers/ver938en.pdf">http://www.moeller.net/binary/ver_techpapers/ver938en.pdf</a>
Mirror Contacts for Highly-Reliable Information Relating to Safety-Related Control Functions	<a href="http://www.moeller.net/binary/ver_techpapers/ver944en.pdf">http://www.moeller.net/binary/ver_techpapers/ver944en.pdf</a>
Effect of the Cable Capacitance of Long Control Cables on the Actuation of Contactors	<a href="http://www.moeller.net/binary/ver_techpapers/ver949en.pdf">http://www.moeller.net/binary/ver_techpapers/ver949en.pdf</a>

Motor starters and "Special Purpose Ratings" for the North American market	<a href="http://www.moeller.net/binary/ver_techpapers/ver953en.pdf">http://www.moeller.net/binary/ver_techpapers/ver953en.pdf</a>
Switchgear for Luminaires	<a href="http://www.moeller.net/binary/ver_techpapers/ver955en.pdf">http://www.moeller.net/binary/ver_techpapers/ver955en.pdf</a>
Standard Compliant and Functionally Safe Engineering Design with Mechanical Auxiliary Contacts	<a href="http://www.moeller.net/binary/ver_techpapers/ver956en.pdf">http://www.moeller.net/binary/ver_techpapers/ver956en.pdf</a>
The Interaction of Contactors with PLCs	<a href="http://www.moeller.net/binary/ver_techpapers/ver957en.pdf">http://www.moeller.net/binary/ver_techpapers/ver957en.pdf</a>
Busbar Component Adapters for modern Industrial control panels	<a href="http://www.moeller.net/binary/ver_techpapers/ver960en.pdf">http://www.moeller.net/binary/ver_techpapers/ver960en.pdf</a>