



OPTIMA-TOP SERIES

SURFACE MOUNTING SOCKETS OUTLETS IP67



■ BEHAVIOUR WITH CHEMICAL AND ATMOSPHERIC AGENTS

Saline solution	Acids		Bases		Solvents				Mineral oil	UV rays
	Concentrated	Diluted	Concentrated	Diluted	Hexane	Benzol	Acetone	Alcohol		
Resistant	Limited Resistance	Resistant	Resistant	Resistant	Not Resistant	Not Resistant	Not Resistant	Limited Resistance	Resistant	Limited Resistance

For specific substances please contact our technical service.

■ WIRING AND INSTALLATION

Wiring capacity of the terminals (mm²)

Max. cable size accepted by the cable clamp:

Rated voltage	Rated current (A)	Plugs, connectors and appliance inlets		Socket outlets	
		Min	Max	Min	Max
Over 50V	16A	1	2,5	1,5	4
	32A	2,5	6	2,5	10
	63A	6	16	6	25
	125A	16	50	25	70

Rated current (A)	Outside Ø mm	
	Min	Max
16A	8	15
32A	11,5	21
63A	17	31
125A	26	48

■ APPLICATION EXAMPLES



Industrial plugs and sockets

■ OPTIMA Series >> Surface mounting socket outlets

OPTIMA-TOP Series

























518.



 **TOP - Screw terminals**

SURFACE MOUNTING SOCKET

IP66/IP67/IP69

Poles	Hz	Volt	Colour	h	SURFACE MOUNTING SOCKET			
					M20X1,5	M25X1,5	M32X1,5	
					16A		32A	
2P+E	50Hz 60Hz	100-130V		4h	518.1650T	10/40	518.3250T	10
		200-250V		6h	518.1653T	10/40	518.3253T	10
		380-415V		9h	518.1658T	10/40	518.3258T	10
		480-500V		7h	518.16536T	10/40	518.32536T	10
		TST>50V		12h	518.16533T	10/40	518.32533T	10
	>300-500Hz	>50V		2h	518.16532T	10/40	518.32532T	10
	DC	>50-250V		3h	518.16534T	10/40	518.32534T	10
		>250V		8h	518.16538T	10/40	518.32538T	10
3P+E	50Hz 60Hz	100-130V		4h	518.1651T	10/40	518.3251T	10
		200-250V		9h	518.1654T	10/40	518.3254T	10
		380-415V		6h	518.1656T	10/40	518.3256T	10
		380V 50Hz / 440V 60Hz		3h	518.16564T	10/40	518.32564T	10
		480-500V		7h	518.16566T	10/40	518.32566T	10
	60Hz	600-690V		5h	518.16567T	10/40	518.32567T	10
	100-300Hz	440-460V		11h	518.16565T	10/40	518.32565T	10
	>300-500Hz	>50V		10h	518.16561T	10/40	518.32561T	10
3P+N+E	50Hz 60Hz	100-130V		4h	518.1652T	10/40	518.3252T	10
		208-250V		9h	518.1655T	10/40	518.3255T	10
		346-415V		6h	518.1657T	10/40	518.3257T	10
		380V 50Hz / 440V 60Hz		3h	518.16574T	10/40	518.32574T	10
		480-500V		7h	518.16576T	10/40	518.32576T	10
	60Hz	600-690V		5h	518.16577T	10/40	518.32577T	10
	>300-500Hz	440-460V		11h	518.16575T	10/40	518.32575T	10
	>300-500Hz	>50V		2h	518.16572T	10/40	518.32572T	10

- Threaded break-through knock out



= Screw terminals



= Spring terminals (fast wiring)

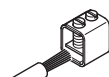

= Mantle terminals

■ OPTIMA Series >> Surface mounting socket outlets

OPTIMA-TOP Series

518.



TOP - Mantle terminals

SURFACE MOUNTING SOCKET

IP66/IP67/IP69

Poles	Hz	Volt	Colour	h	M40X1,5		M63X1,5		
					63A		125A		
2P+E	50Hz 60Hz	100-130V		4h	518.6350T	4	518.12550T	1/4	
		200-250V		6h	518.6353T	4	518.12553T	1/4	
		380-415V		9h	518.6358T	4	518.12558T	1/4	
		480-500V		7h	518.63536T		518.125536T		
		TST>50V		12h	518.63533T		518.125533T		
	DC	>300-500Hz	>50V		2h	518.63532T		518.125532T	
		>50-250V		3h	518.63534T		518.125534T		
		>250V		8h	518.63538T		518.125538T		
3P+E	50Hz 60Hz	100-130V		4h	518.6351T	4	518.12551T	1/4	
		200-250V		9h	518.6354T	4	518.12554T	1/4	
		380-415V		6h	518.6356T	4	518.12556T	1/4	
		380V 50Hz / 440V 60Hz		3h	518.63564T		518.125564T		
		480-500V		7h	518.63566T		518.125566T		
	60Hz	600-690V		5h	518.63567T		518.125567T		
	>300-500Hz	440-460V		11h	518.63565T		518.125565T		
	>100-300Hz	>50V		10h	518.63561T		518.125561T		
3P+N+E	50Hz 60Hz	100-130V		4h	518.6352T	4	518.12552T	1/4	
		208-250V		9h	518.6355T	4	518.12555T	1/4	
		346-415V		6h	518.6357T	4	518.12557T	1/4	
		380V 50Hz / 440V 60Hz		3h	518.63574T		518.125574T		
		480-500V		7h	518.63576T		518.125576T		
	60Hz	600-690V		5h	518.63577T		518.125577T		
	>300-500Hz	440-460V		11h	518.63575T		518.125575T		
	>100-300Hz	>50V		2h	518.63572T		518.125572T		

- Open threaded cable entry
- Cable gland included

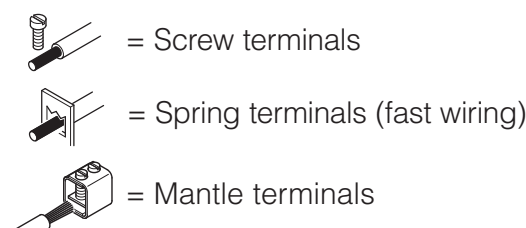

OPTIMA-TOP SERIES

DIMENSIONS

TOP VERSION 16-32A IP67

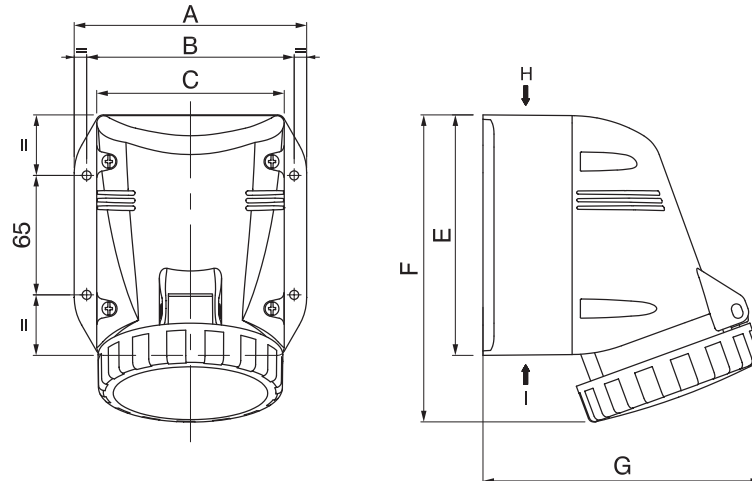

IP66/IP67	A	B	C	D	E	F	G	H	I
2P+E	94	80	70	/	96	131	110	M20X1.5	M20X1.5
16A 3P+E	109	97	85	51	112	146	134	M25X1.5	2X M25X1.5
3P+N+E	109	97	85	51	112	150	135	M25X1.5	2X M25X1.5
2P+E	126	113	102	65	130	166	151	M32X1.5	2X M32X1.5
32A 3P+E	126	113	102	65	130	166	151	M32X1.5	2X M32X1.5
3P+N+E	126	113	102	65	130	167	152	M32X1.5	2X M32X1.5

(Dimension in mm)



www.filippidisandsons.gr