



MASTER LEDspot ExpertColor LV

MASTER LED ExpertColor 6.5-35W MR16 940 24D

MASTER LEDspot LV ExpertColor creates a warm and comfortable ambience for hospitality venues, homes and restaurants. It creates such an ambience with superior lighting that has a customized spectrum, high CRI, and deep dimming feature. The result? A beautiful lighting experience. What's more, the innovative, trimless lens design will suit almost any interior decor with its clean and neat look. In addition, you can take advantage of the full ExpertColor family, which also includes LEDspot MV and LEDspot Par lamps.

Product data

General Information	
Cap-Base	GU5.3 [GU5.3]
Nominal Lifetime (Nom)	40000 h
Switching Cycle	50000X
Technical Type	6.5-35W
Light Technical	
Color Code	940 [CCT of 4000K]
Beam Angle (Nom)	24 °
Luminous Flux (Nom)	460 lm
Luminous Flux (Rated) (Nom)	460 lm
Luminous Intensity (Nom)	2350 cd
Color Designation	Cool White (CW)
Rated Beam Angle	24 °
Correlated Color Temperature (Nom)	4000 K
Luminous Efficacy (rated) (Nom)	70.77 lm/W
Color Consistency	<3

Color Rendering Index (Nom)	97
LLMF At End Of Nominal Lifetime (Nom)	70 %
Luminous Flux In 90° Cone (Rated)	460 lm
Operating and Electrical	
Power (Rated) (Nom)	6.5 W
Lamp Current (Nom)	800 mA
Wattage Equivalent	35 W
Starting Time (Nom)	0.5 s
Warm Up Time To 60% Light (Nom)	0.5 s
Power Factor (Nom)	0.7
Voltage (Nom)	ac electronic 12 V
Temperature	
T-Case Maximum (Nom)	90 °C

MASTER LEDspot ExpertColor LV

Controls and Dimming

Dimmable	Yes
----------	-----

Approval and Application

Suitable For Accent Lighting	Yes
------------------------------	-----

Energy Efficiency Label (EEL)	A+
-------------------------------	----

Energy Consumption kWh/1000 h	8 kWh
-------------------------------	-------

Product Data

Full product code	871869673881800
-------------------	-----------------

Order product name	MASTER LED ExpertColor 6.5-35W MR16 940 24D
--------------------	---

EAN/UPC - Product	8718696738818
-------------------	---------------

Order code	929001342202
------------	--------------

Numerator - Quantity Per Pack	1
-------------------------------	---

Numerator - Packs per outer box	10
---------------------------------	----

Material Nr. (12NC)	929001342202
---------------------	--------------

Net Weight (Piece)	0.030 kg
--------------------	----------

Dimensional drawing

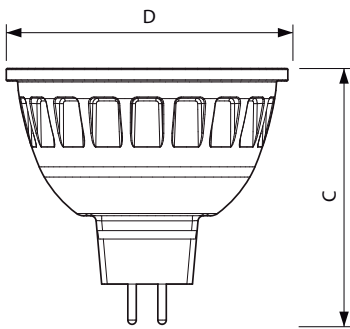

MR16 12V 6.5-42W 450lm 25D 4000K GU5.3 D

Product	D	C
MASTER LED ExpertColor 6.5-35W MR16 940 24D	51 mm	46 mm

Photometric data

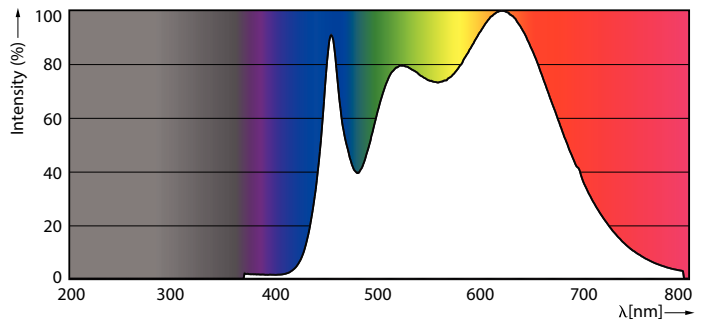
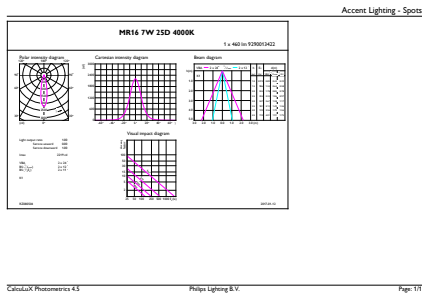

LEDspots MR16 7W 4000K

MASTER LEDspot ExpertColor LV

