



**Adjustable roller lever, D=30mm**

**Part no.** LS-XRLA30  
**Catalog No.** 266128  
**Eaton Catalog No.** LS-XRLA30  
**EL-Nummer** 0004356129  
**(Norway)**

**Delivery program**

Basic function			Operating heads
Part group reference			LS(M)-...
Product range			Adjustable roller lever
Diameter	∅	mm	30
For use with			Basic devices LS(M)...

**Notes** The operating head can be rotated at 90° intervals to adapt to the specified approach direction.

**Design verification as per IEC/EN 61439**

Technical data for design verification			
Rated operational current for specified heat dissipation	I <sub>n</sub>	A	0
Heat dissipation per pole, current-dependent	P <sub>vid</sub>	W	0
Equipment heat dissipation, current-dependent	P <sub>vid</sub>	W	0
Static heat dissipation, non-current-dependent	P <sub>vs</sub>	W	0
Heat dissipation capacity	P <sub>diss</sub>	W	0
Operating ambient temperature min.		°C	-40
Operating ambient temperature max.		°C	70
IEC/EN 61439 design verification			
10.2 Strength of materials and parts			
10.2.2 Corrosion resistance			
			Meets the product standard's requirements.
10.2.3.1 Verification of thermal stability of enclosures			
			Meets the product standard's requirements.
10.2.3.2 Verification of resistance of insulating materials to normal heat			
			Meets the product standard's requirements.
10.2.3.3 Verification of resistance of insulating materials to abnormal heat and fire due to internal electric effects			
			Meets the product standard's requirements.
10.2.4 Resistance to ultra-violet (UV) radiation			
			Please enquire
10.2.5 Lifting			
			Does not apply, since the entire switchgear needs to be evaluated.
10.2.6 Mechanical impact			
			Does not apply, since the entire switchgear needs to be evaluated.
10.2.7 Inscriptions			
			Meets the product standard's requirements.
10.3 Degree of protection of ASSEMBLIES			
			Does not apply, since the entire switchgear needs to be evaluated.
10.4 Clearances and creepage distances			
			Meets the product standard's requirements.
10.5 Protection against electric shock			
			Does not apply, since the entire switchgear needs to be evaluated.
10.6 Incorporation of switching devices and components			
			Does not apply, since the entire switchgear needs to be evaluated.
10.7 Internal electrical circuits and connections			
			Is the panel builder's responsibility.
10.8 Connections for external conductors			
			Is the panel builder's responsibility.
10.9 Insulation properties			
10.9.2 Power-frequency electric strength			
			Is the panel builder's responsibility.
10.9.3 Impulse withstand voltage			
			Is the panel builder's responsibility.
10.9.4 Testing of enclosures made of insulating material			
			Is the panel builder's responsibility.
10.10 Temperature rise			
			Not applicable.
10.11 Short-circuit rating			
			Is the panel builder's responsibility. The specifications for the switchgear must be observed.
10.12 Electromagnetic compatibility			
			Is the panel builder's responsibility. The specifications for the switchgear must be observed.

## Technical data ETIM 7.0

Sensors (EG000026) / Drive head for position switches/hinge switches (EC001483)

Electric engineering, automation, process control engineering / Binary sensor technology, safety-related sensor technology / Position switch / Drive head for position switches (ecl@ss10.0.1-27-27-06-04 [BAA083012])

Type of control element

Adjustable roller lever

## Approvals

Product Standards

IEC/EN 60947-5; UL 508; CSA-C22.2 No. 14; CE marking

UL File No.

E29184

UL Category Control No.

NKCR

CSA File No.

12528

CSA Class No.

3211-03

North America Certification

UL listed, CSA certified

## Dimensions

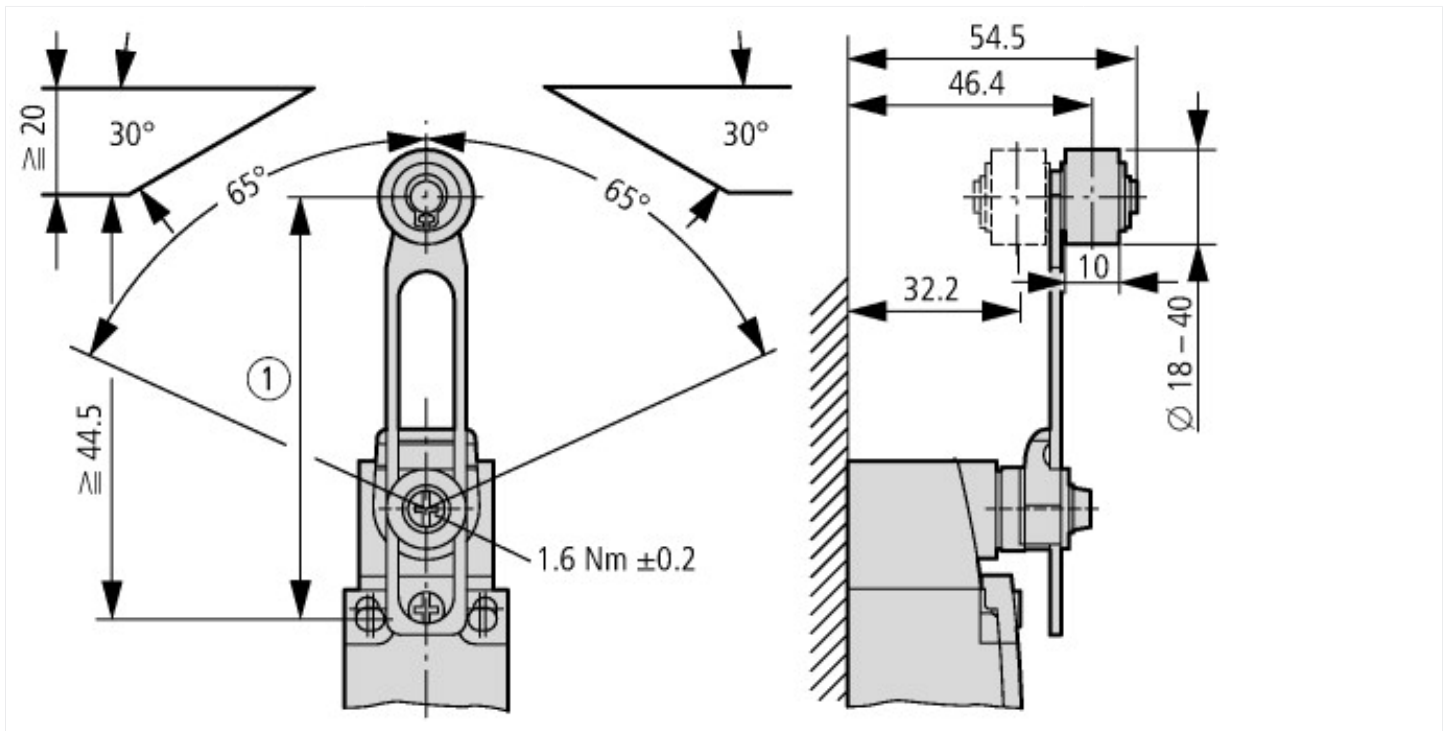

① Setting range of 54.5 to 97

## Additional product information (links)

IL053001ZU LS-Titan position switch: basic device

IL053001ZU LS-Titan position switch: basic device

[ftp://ftp.moeller.net/DOCUMENTATION/AWA\\_INSTRUCTIONS/IL053001ZU2018\\_06.pdf](ftp://ftp.moeller.net/DOCUMENTATION/AWA_INSTRUCTIONS/IL053001ZU2018_06.pdf)