







Position switch, 1N/O+1N/C, roller lever, short

Part no. LS-11/LS
Catalog No. 290173
Eaton Catalog No. LS-11-LS
EL-Nummer (Norway) 0004315231

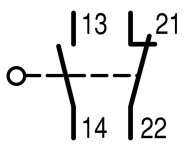
Delivery program

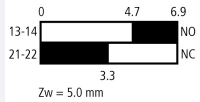
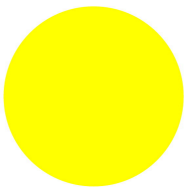
| | | | |
|--|--|----|---|
| Basic function | | | Position switches Safety position switches |
| Part group reference | | | LS(M)-... |
| Product range | | | Roller lever |
| Degree of Protection | | | IP66, IP67 |
| Features | | | Complete unit |
| Ambient temperature | | °C | -25 - +70 |
| Description | | | Short |
| Contacts | | | |
| N/O = Normally open | | | 1 N/O |
| N/C = Normally closed | | | 1 NC  |
| Notes | | |  = safety function, by positive opening to IEC/EN 60947-5-1 |
| Contact sequence | | |  |
| Contact travel  = Contact closed  = Contact open | | |  |
| Positive opening (ZW) | | | yes |
| Colour | | | |
| Enclosure covers | | | Yellow |
| Enclosure covers | | |  |
| Housing | | | Insulated material |
| Connection type | | | Cage Clamp |
| Notes | | | Cage-Clamp is a registered trademark of Wago Kontakttechnik, 32432 Minden, Germany. Accessories for the Cage-Clamp terminals from Wago: power comb, gray, Wago Article No. 264-402 |
| Notes The operating head can be rotated at 90° intervals to adapt to the specified approach direction. | | | |

Technical data

| | | | |
|----------------------|--|----|--|
| General | | | |
| Standards | | | IEC/EN 60947 |
| Climatic proofing | | | Damp heat, constant, to IEC 60068-2-78; damp heat, cyclical, to IEC 60068-2-30 |
| Ambient temperature | | °C | -25 - +70 |
| Mounting position | | | As required |
| Degree of Protection | | | IP66, IP67 |

| | | | |
|-----------------------|--|-----------------|-----------------|
| Terminal capacities | | mm ² | |
| Solid | | mm ² | 1 x (0.5 - 2.5) |
| Flexible with ferrule | | mm ² | 1 x (0.5 - 1.5) |

Contacts/switching capacity

| | | | |
|--|------------------|-------------------|--|
| Rated impulse withstand voltage | U _{imp} | V AC | 4000 |
| Rated insulation voltage | U _i | V | 400 |
| Overvoltage category/pollution degree | | | III/3 |
| Rated operational current | I _e | A | |
| AC-15 | | | |
| 24 V | I _e | A | 6 |
| 220 V 230 V 240 V | I _e | A | 6 |
| 380 V 400 V 415 V | I _e | A | 4 |
| DC-13 | | | |
| 24 V | I _e | A | 3 |
| 110 V | I _e | A | 0.6 |
| 220 V | I _e | A | 0.3 |
| Control circuit reliability | | | |
| at 24 V DC/5 mA | H _F | Fault probability | < 10 ⁻⁷ , < 1 fault in 10 ⁷ operations |
| at 5 V DC/1 mA | H _F | Fault probability | < 10 ⁻⁶ , < 1 failure at 5 x 10 ⁶ operations |
| Supply frequency | | Hz | max. 400 |
| Short-circuit rating to IEC/EN 60947-5-1 | | | |
| max. fuse | | A gG/gL | 6 |
| Repetition accuracy | | mm | 0.15 |
| Rated conditional short-circuit current | | kA | 1 |

Mechanical variables

| | | | |
|--|--------------|-------------------|--------|
| Lifespan, mechanical | Operations | x 10 ⁶ | 8 |
| Mechanical shock resistance (half-sinusoidal shock, 20 ms) | | | |
| Standard-action contact | | g | 25 |
| Operating frequency | Operations/h | | ≤ 6000 |

Actuation

| | | | |
|--|--|-----|------------------------------------|
| Mechanical | | | |
| Actuating force at beginning/end of stroke | | N | 1.0/8.0 |
| Actuating torque of rotary drives | | Nm | 0.2 |
| Max. operating speed with DIN cam | | m/s | 1 |
| Notes | | | for angle of actuation α = 30°/45° |

Design verification as per IEC/EN 61439

| | | | |
|--|-------------------|----|--|
| Technical data for design verification | | | |
| Rated operational current for specified heat dissipation | I _n | A | 6 |
| Heat dissipation per pole, current-dependent | P _{vid} | W | 0.17 |
| Equipment heat dissipation, current-dependent | P _{vid} | W | 0 |
| Static heat dissipation, non-current-dependent | P _{vs} | W | 0 |
| Heat dissipation capacity | P _{diss} | W | 0 |
| Operating ambient temperature min. | | °C | -25 |
| Operating ambient temperature max. | | °C | 70 |
| IEC/EN 61439 design verification | | | |
| 10.2 Strength of materials and parts | | | |
| 10.2.2 Corrosion resistance | | | Meets the product standard's requirements. |
| 10.2.3.1 Verification of thermal stability of enclosures | | | Meets the product standard's requirements. |
| 10.2.3.2 Verification of resistance of insulating materials to normal heat | | | Meets the product standard's requirements. |
| 10.2.3.3 Verification of resistance of insulating materials to abnormal heat and fire due to internal electric effects | | | Meets the product standard's requirements. |
| 10.2.4 Resistance to ultra-violet (UV) radiation | | | Meets the product standard's requirements. |

| | | |
|--|--|--|
| 10.2.5 Lifting | | Does not apply, since the entire switchgear needs to be evaluated. |
| 10.2.6 Mechanical impact | | Does not apply, since the entire switchgear needs to be evaluated. |
| 10.2.7 Inscriptions | | Meets the product standard's requirements. |
| 10.3 Degree of protection of ASSEMBLIES | | Does not apply, since the entire switchgear needs to be evaluated. |
| 10.4 Clearances and creepage distances | | Meets the product standard's requirements. |
| 10.5 Protection against electric shock | | Does not apply, since the entire switchgear needs to be evaluated. |
| 10.6 Incorporation of switching devices and components | | Does not apply, since the entire switchgear needs to be evaluated. |
| 10.7 Internal electrical circuits and connections | | Is the panel builder's responsibility. |
| 10.8 Connections for external conductors | | Is the panel builder's responsibility. |
| 10.9 Insulation properties | | |
| 10.9.2 Power-frequency electric strength | | Is the panel builder's responsibility. |
| 10.9.3 Impulse withstand voltage | | Is the panel builder's responsibility. |
| 10.9.4 Testing of enclosures made of insulating material | | Is the panel builder's responsibility. |
| 10.10 Temperature rise | | The panel builder is responsible for the temperature rise calculation. Eaton will provide heat dissipation data for the devices. |
| 10.11 Short-circuit rating | | Is the panel builder's responsibility. The specifications for the switchgear must be observed. |
| 10.12 Electromagnetic compatibility | | Is the panel builder's responsibility. The specifications for the switchgear must be observed. |
| 10.13 Mechanical function | | The device meets the requirements, provided the information in the instruction leaflet (IL) is observed. |

Technical data ETIM 7.0

Sensors (EG000026) / End switch (EC000030)

Electric engineering, automation, process control engineering / Binary sensor technology, safety-related sensor technology / Position switch / Position switch (Type 1)
(ecl@ss10.0.1-27-27-06-01 [AGZ382015])

| | | |
|--|----|--------------------|
| Width sensor | mm | 31 |
| Diameter sensor | mm | 0 |
| Height of sensor | mm | 61 |
| Length of sensor | mm | 33.5 |
| Rated operation current I _e at AC-15, 24 V | A | 6 |
| Rated operation current I _e at AC-15, 125 V | A | 6 |
| Rated operation current I _e at AC-15, 230 V | A | 6 |
| Rated operation current I _e at DC-13, 24 V | A | 3 |
| Rated operation current I _e at DC-13, 125 V | A | 0.8 |
| Rated operation current I _e at DC-13, 230 V | A | 0.3 |
| Switching function | | Slow-action switch |
| Switching function latching | | No |
| Output electronic | | No |
| Forced opening | | Yes |
| Number of safety auxiliary contacts | | 1 |
| Number of contacts as normally closed contact | | 1 |
| Number of contacts as normally open contact | | 1 |
| Number of contacts as change-over contact | | 0 |
| Type of interface | | None |
| Type of interface for safety communication | | None |
| Construction type housing | | Cuboid |
| Material housing | | Plastic |
| Coating housing | | Other |
| Type of control element | | Roller lever |
| Alignment of the control element | | Other |
| Type of electric connection | | Other |
| With status indication | | No |
| Suitable for safety functions | | Yes |
| Explosion safety category for gas | | None |
| Explosion safety category for dust | | None |
| Ambient temperature during operating | °C | 25 - 70 |

| | | |
|-----------------------------|--|------|
| Degree of protection (IP) | | IP67 |
| Degree of protection (NEMA) | | 4X |

Approvals

| | | |
|-----------------------------|--|---|
| Product Standards | | IEC/EN 60947-5; UL 508; CSA-C22.2 No. 14; CE marking |
| UL File No. | | E29184 |
| UL Category Control No. | | NKCR |
| CSA File No. | | 12528 |
| CSA Class No. | | 3211-03 |
| North America Certification | | UL listed, CSA certified |
| Degree of Protection | | IEC: IP66, 67, UL/CSA Type 3R, 4X (indoor use only), 12, 13 |

Dimensions

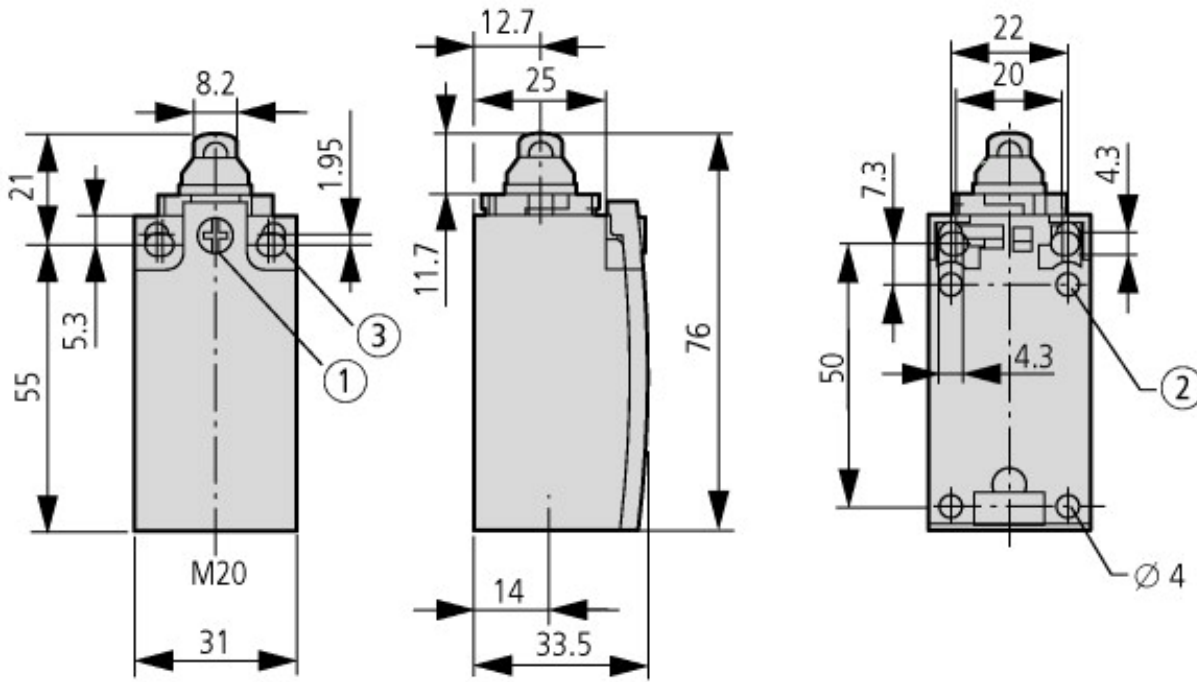

- ① Tightening torque of cover screws: 0.8 Nm ± 0.2 Nm
 - ② only with LS (insulated version)
 - ③ Fixing screws 2 x M4 ≥ 30
- $M_A = 1.5$ Nm

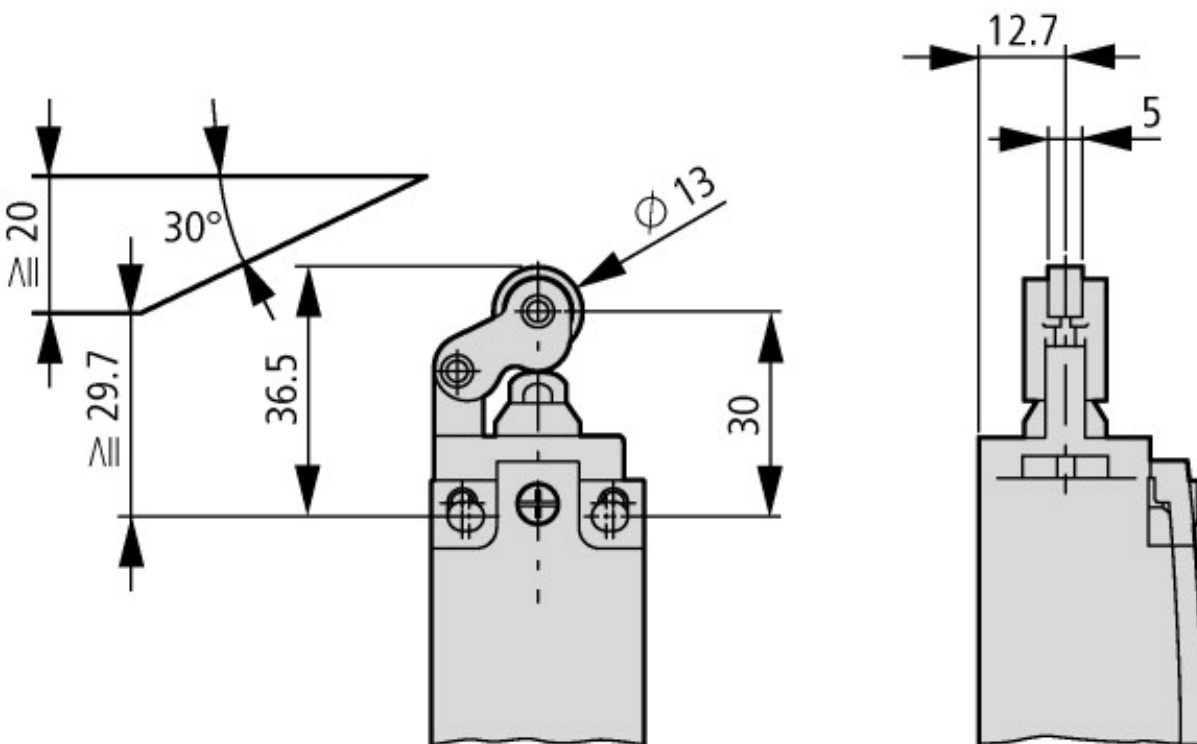

Additional product information (links)

IL053001ZU LS-Titan position switch: basic device

IL053001ZU LS-Titan position switch: basic device

ftp://ftp.moeller.net/DOCUMENTATION/AWA_INSTRUCTIONS/IL053001ZU2018_06.pdf