



Miniature power relays 12 A



Industrial furnaces and ovens



Control and management of electric power



Industrial motors



Circuit breakers and switches



Panels for electrical distribution



Control panels



Carousel warehouses



Vending machines

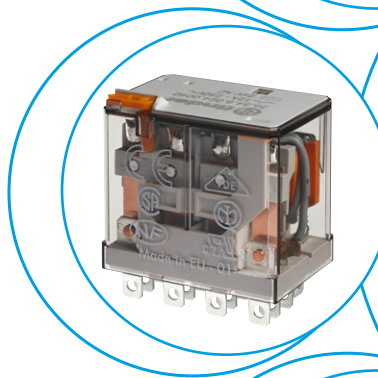

Printed circuit mount

12 A Power relay

- 2 & 4 pole
- AC coils & DC coils
- Cadmium Free contacts (standard version)
- Contact material option

A

56.42/56.44



- 2 or 4 pole changeover contact
- PCB mount

56.42-0300



- 2 pole normally open contact (≥ 1.5 mm gap)
- PCB mount

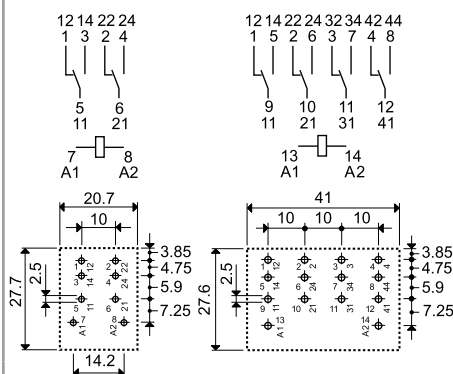

56.42
Copper side view

56.44
Copper side view

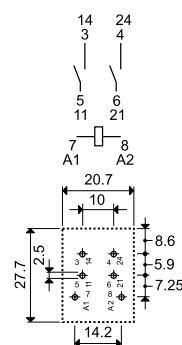

56.42-0300
Copper side view

* For 4 CO (4PDT) only.

FOR UL RATINGS SEE:

"General technical information" page V

For outline drawing see page 8

Contact specification

| | | | | |
|---|-----------|-------------|-------------|------------------------------|
| Contact configuration | | 2 CO (DPDT) | 4 CO (4PDT) | 2NO (DPST-NO) - ≥ 1.5 mm gap |
| Rated current/Maximum peak current | A | 12/20 | | 12/20 |
| Rated voltage/ Maximum switching voltage | V AC | 250/400 | | 250/400 |
| Rated load AC1 | VA | 3000 | | 3000 |
| Rated load AC15 (230 V AC) | VA | 700 | | 700 |
| Single phase motor rating (230 V AC) | kW | 0.55 | | 0.55 |
| Breaking capacity DC1: 30/110/220 V | A | 12/0.5/0.25 | | 12/1/0.5 |
| Minimum switching load | mW (V/mA) | 500 (10/5) | | 500 (10/5) |
| Standard contact material | | AgNi | | AgNi |

Coil specification

| | | | | |
|-----------------------------------|-----------------|--|---------------------------|----------------------------|
| Nominal voltage (U _N) | V AC (50/60 Hz) | 6 - 12 - 24 - 48 - 60 - 110 - 120 - 230 - 240 - 400* | | |
| | V DC | 6 - 12 - 24 - 48 - 60 - 110 - 125 - 220 | | — |
| Rated power AC/DC | VA (50 Hz)/W | 1.5/1 | 2/1.3 | 1.5/— |
| Operating range | AC | (0.8...1.1)U _N | | (0.85...1.1)U _N |
| | DC | (0.8...1.1)U _N | (0.8...1.1)U _N | — |
| Holding voltage | AC/DC | 0.8 U _N / 0.6 U _N | | 0.85 U _N /— |
| Must drop-out voltage | AC/DC | 0.2 U _N / 0.1 U _N | | 0.2 U _N /— |

Technical data

| | | | | |
|--|--------|--|-------|-------------------------|
| Mechanical life AC/DC | cycles | 20 · 10 ⁶ /50 · 10 ⁶ | | 20 · 10 ⁶ /— |
| Electrical life at rated load AC1 | cycles | 100 · 10 ³ | | 100 · 10 ³ |
| Operate/release time | ms | 9/6 | 11/11 | 8/4 |
| Insulation between coil and contacts (1.2/50 μs) | kV | 4 | 5 | 4 |
| Dielectric strength between open contacts | V AC | 1000 | | 2000 |
| Ambient temperature range | °C | -40...+70 | | -40...+70 |
| Environmental protection | | RT I | | RT I |

Approvals (according to type)



Ordering information

Example: 56 series plug-in relay, 2 CO (DPDT), 12 V DC coil, lockable test button and mechanical indicator.

| | | |
|---|--|---|
| <p>Series — 5 6</p> <p>Type — 3</p> <p>3 = Plug-in 4 = PCB</p> <p>No. of poles — 2 . 9</p> <p>2 = 2 pole, 12 A 4 = 4 pole, 12 A</p> <p>Coil version — 0 1 2</p> <p>8 = AC (50/60 Hz) 9 = DC</p> <p>Coil voltage — 0</p> <p>See coil specifications</p> | <p>A: Contact material 0 = Standard AgNi 2 = AgCdO 4 = AgSnO₂</p> <p>B: Contact circuit 0 = CO (nPDT) 3 = NO (nPST), ≥ 1.5 mm contact gap</p> | <p>C — 0 0 4 0</p> <p>D — 0</p> <p>D: Special versions 0 = Standard 6 = Rear flange mount (4 pole only) 8 = Rear 35 mm rail mount (4 pole only) For other mounting options see page 9</p> <p>C: Options 0 = None 2 = Mechanical indicator 3* = LED (AC) 4 = Lockable test button + mechanical indicator 5* = Lockable test button + LED (AC) 54* = Lockable test button + LED (AC) + mechanical indicator 6* = Double LED (DC non-polarized) 7* = Lockable test button + double LED (DC non-polarized) 74* = Lockable test button + double LED (DC non-polarized) + mechanical indicator 8* = LED + diode (DC, polarity positive to pin 7) for 56.32 only 9* = Lockable test button + LED + diode (DC, polarity positive to pin 7) for 56.32 only 94* = Lockable test button + LED + diode (DC, polarity positive to pin 7) + mechanical indicator for 56.32 only * Options not available for 220 V DC and 400 V AC versions.</p> |
|---|--|---|

Selecting features and options: only combinations in the same row are possible.

Preferred selections for best availability are shown in **bold**.

| Type | Coil version | A | B | C | D |
|-------|--------------|------------------|----------|----------------------------------|------------------|
| 56.32 | AC | 0 - 2 - 4 | 0 | 0 - 2 - 3 - 4 - 5 | 0 |
| | AC | 0 - 2 - 4 | 0 | 54 | / |
| | AC | 0 - 2 - 4 | 3 | 0 - 3 - 5 | 0 |
| | DC | 0 - 2 - 4 | 0 | 0 - 2 - 4 - 6 - 7 - 8 - 9 | 0 |
| | DC | 0 - 2 - 4 | 0 | 74 - 94 | / |
| 56.34 | AC | 0 - 2 - 4 | 0 | 0 - 2 - 3 - 4 - 5 | 0 - 6 - 8 |
| | AC | 0 - 2 - 4 | 0 | 54 | / |
| | DC | 0 - 2 - 4 | 0 | 0 - 2 - 4 - 6 - 7 | 0 - 6 - 8 |
| | DC | 0 - 2 - 4 | 0 | 74 | / |
| 56.42 | DC | 0 - 2 - 4 | 0 | 0 | 0 |
| | AC | 0 - 2 - 4 | 0 - 3 | 0 | 0 |
| 56.44 | AC - DC | 0 - 2 - 4 | 0 | 0 | 0 |

Special versions for Rail Applications on request

Descriptions: options and special versions

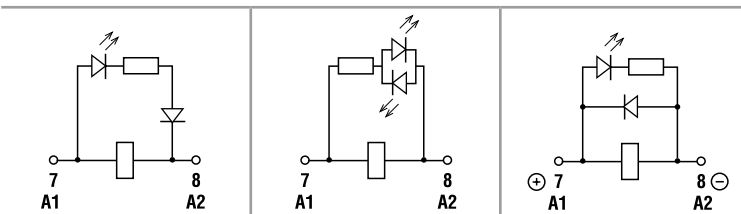

C: Option 3, 5, 54
LED (AC)

C: Option 6, 7, 74
Double LED
(DC non-polarized)

C: Option 8, 9, 94
LED + diode (DC, polarity positive to pin 7) - (56.32 only)

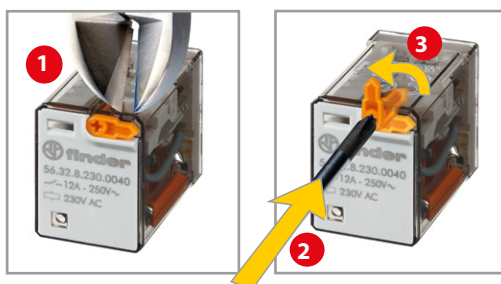

Lockable test button and mechanical flag indicator (0040, 0050, 0054, 0070, 0074, 0090, 0094)

The dual-purpose Finder test button can be used in two ways:

Case 1) The plastic pip (located directly above the test button) remains intact. In this case, when the test button is pushed, the contacts operate. When the test button is released the contacts return to their former state.

Case 2) The plastic pip is broken-off (using an appropriate cutting tool). In this case, (in addition to the above function), when the test button is pushed and rotated, the contacts are latched in the operating state, and remain so until the test button is rotated back to its former position.

In both cases ensure that the test button actuation is swift and decisive.

Technical data

* Only in applications where over voltage category II is permitted. In applications of over voltage category III: Micro-disconnection.

| Insulation according to EN 61810-1 | | 2 CO - 4 CO | | 2 NO | |
|---|--------------------------|-------------------------|--------------------|---------------------|--------------------|
| Nominal voltage of supply system | V AC | 230/400 | | 230/400 | |
| Rated insulation voltage | V AC | 250 | 400 | 250 | 400 |
| Pollution degree | | 3 | 2 | 3 | 2 |
| Insulation between coil and contact set | | | | | |
| Type of Insulation | | Basic | | Basic | |
| Overvoltage category | | III | | III | |
| Rated impulse voltage | kV (1.2/50 μ s) | 4 | | 4 | |
| Dielectric strength | V AC | 2500 | | 2500 | |
| Insulation between adjacent contacts | | | | | |
| Type of insulation | | Basic | | Basic | |
| Overvoltage category | | III | | III | |
| Rated impulse voltage | kV (1.2/50 μ s) | 4 | | 4 | |
| Dielectric strength | V AC | 2500 | | 2500 | |
| Insulation between open contacts | | | | | |
| Type of disconnection | | Micro-disconnection | | Full-disconnection* | |
| Overvoltage category | | — | | II | |
| Rated impulse voltage | kV (1.2/50 μ s) | — | | 2.5 | |
| Dielectric strength | V AC/kV (1.2/50 μ s) | 1000/1.5 | | 2000/3 | |
| Insulation between coil terminals | | | | | |
| Rated impulse voltage (surge) differential mode (according to EN 61000-4-5) | kV (1.2/50 μ s) | 4 | | | |
| Other data | | | | | |
| Bounce time: NO/NC | ms | 1/4 (2 CO) , 1/7 (4 CO) | | 3/— (normally open) | |
| Vibration resistance (5...55)Hz: NO/NC | g | 17/14 | | | |
| Shock resistance | g | 20/14 | | | |
| Power lost to the environment | without contact current | W | 1 (56.32, 56.42) | | 1.3 (56.34, 56.44) |
| | with rated current | W | 3.8 (56.32, 56.42) | | 6.9 (56.34, 56.44) |
| Recommended distance between relays mounted on PCB | mm | ≥ 5 | | | |

Contact specification

F 56 - Electrical life (AC) v contact current

2 - 4 pole relays

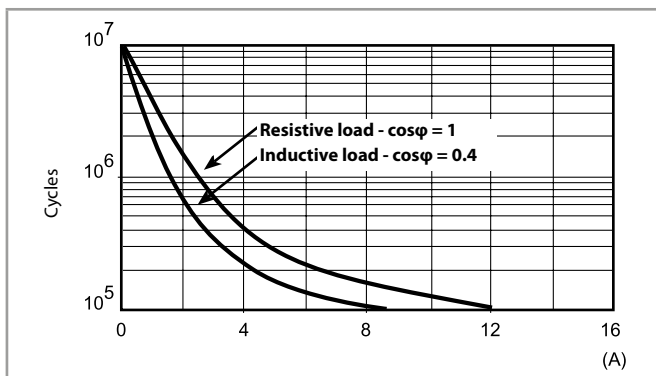

H 56 - Maximum DC1 breaking capacity

Changeover version

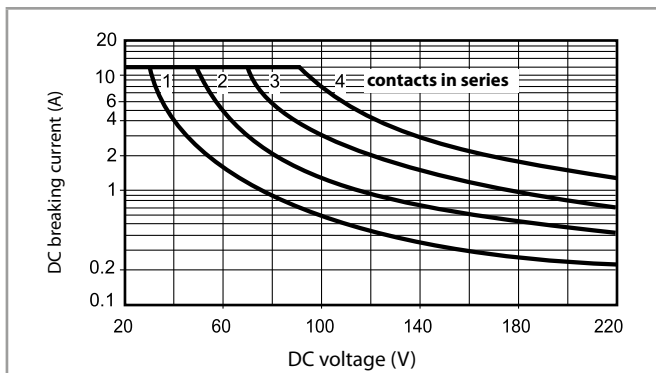

H 56 - Maximum DC1 breaking capacity

Normally open version

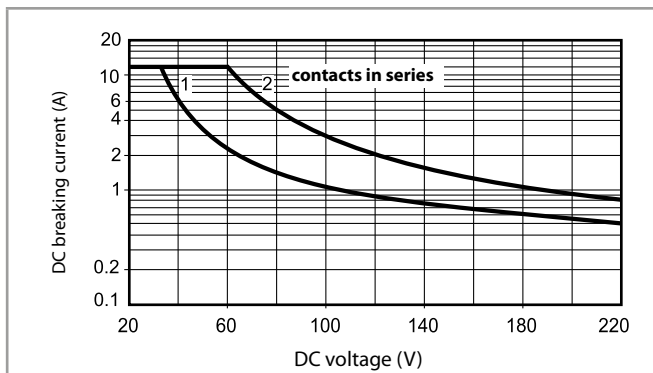

- When switching a resistive load (DC1) having voltage and current values under the curve, an electrical life of $\geq 100 \cdot 10^3$ can be expected.
- In the case of DC13 loads, the connection of a diode in parallel with the load will permit a similar electrical life as for a DC1 load.

Note: the release time of the load will be increased.

Coil specifications

DC coil data, 2 pole relay

| Nominal voltage U_N | Coil code | Operating range | | Resistance R | Rated coil consumption I at U_N |
|--------------------------|-----------|-----------------|-----------|-------------------|--|
| | | U_{min} | U_{max} | | |
| V | | V | V | Ω | mA |
| 6 | 9.006 | 4.8 | 6.6 | 40 | 150 |
| 12 | 9.012 | 9.6 | 13.2 | 140 | 86 |
| 24 | 9.024 | 19.2 | 26.4 | 600 | 40 |
| 48 | 9.048 | 38.4 | 52.8 | 2400 | 20 |
| 60 | 9.060 | 48 | 66 | 4000 | 15 |
| 110 | 9.110 | 88 | 121 | 12500 | 8.8 |
| 125 | 9.125 | 100 | 138 | 17300 | 7.2 |
| 220 | 9.220 | 176 | 242 | 54000 | 4 |

DC coil data, 4 pole relay

| Nominal voltage U_N | Coil code | Operating range | | Resistance R | Rated coil consumption I at U_N |
|--------------------------|-----------|-----------------|-----------|-------------------|--|
| | | U_{min} | U_{max} | | |
| V | | V | V | Ω | mA |
| 6 | 9.006 | 4.8 | 6.6 | 32.5 | 185 |
| 12 | 9.012 | 9.6 | 13.2 | 123 | 97 |
| 24 | 9.024 | 19.2 | 26.4 | 490 | 49 |
| 48 | 9.048 | 38.4 | 52.8 | 1800 | 27 |
| 60 | 9.060 | 48 | 66 | 3000 | 20 |
| 110 | 9.110 | 88 | 121 | 10400 | 10.5 |
| 125 | 9.125 | 100 | 138 | 14200 | 8.8 |
| 220 | 9.220 | 176 | 242 | 44000 | 5 |

R 56 - DC coil operating range v ambient temperature
2 and 4 pole relay

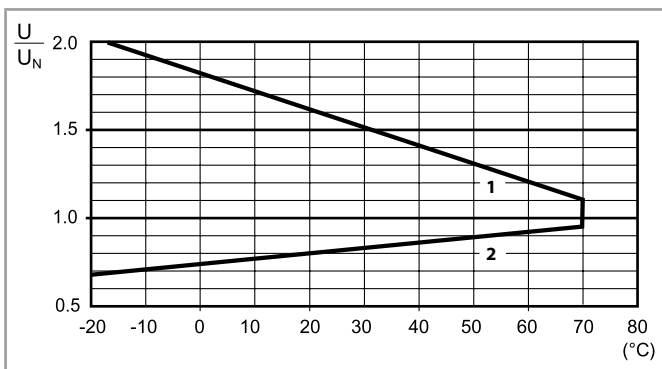

- 1 - Max. permitted coil voltage.
- 2 - Min. pick-up voltage with coil at ambient temperature.

AC coil data, 2 pole relay

| Nominal voltage U_N | Coil code | Operating range | | Resistance R | Rated coil consumption I at U_N (50 Hz) |
|--------------------------|-----------|-----------------|-----------|-------------------|--|
| | | U_{min}^* | U_{max} | | |
| V | | V | V | Ω | mA |
| 6 | 8.006 | 4.8 | 6.6 | 12 | 200 |
| 12 | 8.012 | 9.6 | 13.2 | 50 | 97 |
| 24 | 8.024 | 19.2 | 26.4 | 190 | 53 |
| 48 | 8.048 | 38.4 | 52.8 | 770 | 25 |
| 60 | 8.060 | 48 | 66 | 1200 | 21 |
| 110 | 8.110 | 88 | 121 | 3940 | 12.5 |
| 120 | 8.120 | 96 | 132 | 4700 | 12 |
| 230 | 8.230 | 184 | 253 | 17000 | 6 |
| 240 | 8.240 | 192 | 264 | 19100 | 5.3 |

* $U_{min} = 0.85 U_N$ for normally open version.

AC coil data, 4 pole relay

| Nominal voltage U_N | Coil code | Operating range | | Resistance R | Rated coil consumption I at U_N (50 Hz) |
|--------------------------|-----------|-----------------|-----------|-------------------|--|
| | | U_{min} | U_{max} | | |
| V | | V | V | Ω | mA |
| 6 | 8.006 | 4.8 | 6.6 | 5.7 | 300 |
| 12 | 8.012 | 9.6 | 13.2 | 22 | 150 |
| 24 | 8.024 | 19.2 | 26.4 | 81 | 90 |
| 48 | 8.048 | 38.4 | 52.8 | 380 | 37 |
| 60 | 8.060 | 48 | 66 | 600 | 30 |
| 110 | 8.110 | 88 | 121 | 1900 | 16.5 |
| 120 | 8.120 | 96 | 132 | 2560 | 13.4 |
| 230 | 8.230 | 184 | 253 | 7700 | 9 |
| 240 | 8.240 | 192 | 264 | 10000 | 7.5 |
| 400 | 8.400 | 320 | 440 | 26000 | 4.9 |

R 56 - AC coil operating range v ambient temperature
2 pole relay

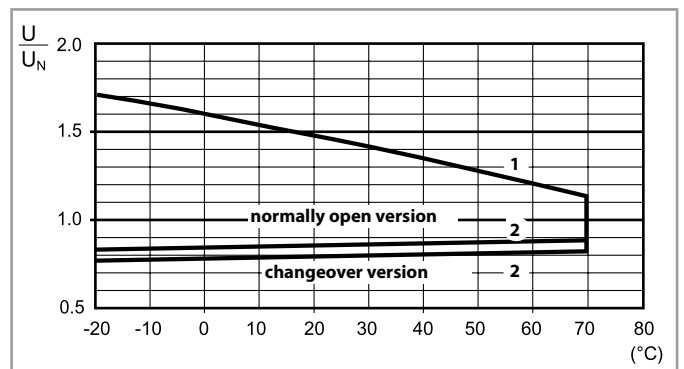

R 56 - AC coil operating range v ambient temperature
4 pole relay

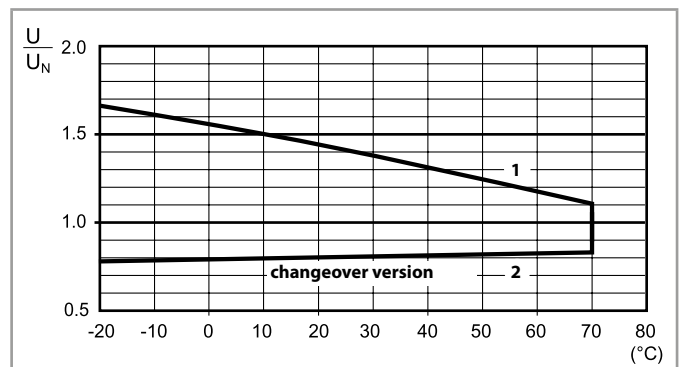

- 1 - Max. permitted coil voltage.
- 2 - Min. pick-up voltage with coil at ambient temperature.

Outline drawings

Types 56.32/32-0300

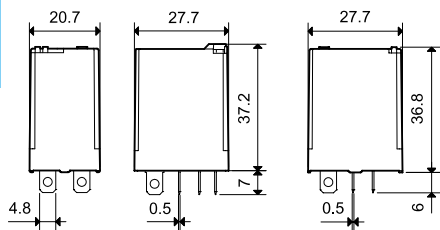

Type 56.34

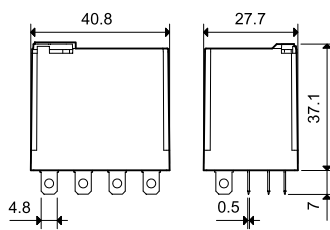

Types 56.42/42-0300

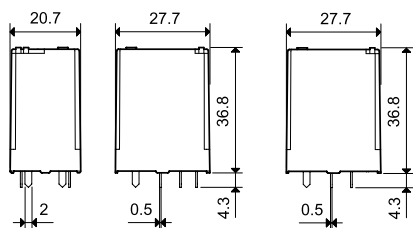

Type 56.44

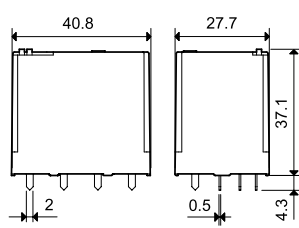

Accessories



056.25



056.25 with relay

Top flange mount adaptor for 56.32

056.25

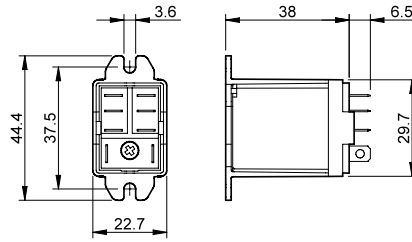

056.25 with relay



056.26



056.26 with relay

Rear flange mount adaptor for 56.32

056.26

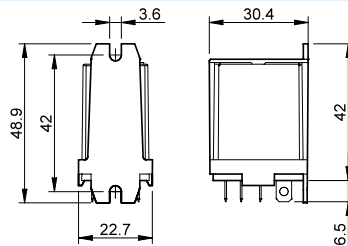

056.26 with relay



056.27



056.27 with relay

Top 35 mm rail (EN 60715) adaptor for 56.32

056.27

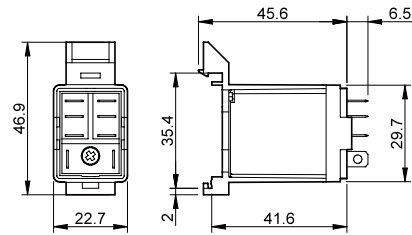

056.27 with relay



056.45



056.45 with relay

Top flange mount adaptor for 56.34

056.45

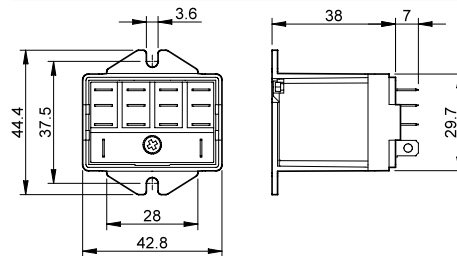

056.45 with relay



056.47



056.47 with relay

Top 35 mm rail (EN 60715) adaptor for 56.34

056.47

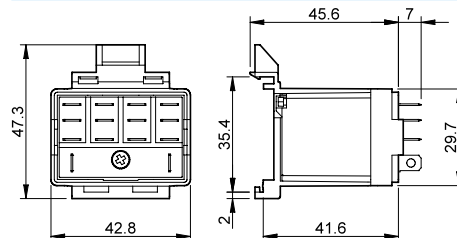

056.47 with relay

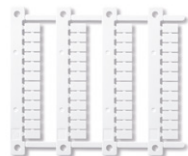

060.48

Sheet of marker tags for relay type 56.34, plastic, 48 tags, 6 x 12 mm, for CEMBRE thermal transfer printers

060.48

A

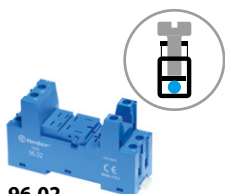

96.02
Approvals
(according to type):

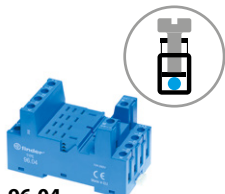

96.04
Approvals
(according to type):



094.91.3

| Screw terminal (Box clamp) socket panel or 35 mm rail mount (EN 60715) | 96.02 Blue | 96.02.0 Black | 96.04 Blue | 96.04.0 Black |
|---|--------------------------------|------------------|-----------------|------------------|
| For relay type | 56.32 | | 56.34 | |
| Accessories | | | | |
| Metal retaining clip (supplied with socket - packaging code SMA) | 094.71 | | 096.71 | |
| Plastic retaining and release clip (supplied with socket - packaging code SPA) | 094.91.3 | 094.91.30 | — | — |
| 6-way jumper link | 094.06 | 094.06.0 | — | — |
| Identification tag | 095.00.4 | | 090.00.2 | |
| Modules (see table below) | 99.02 | | | |
| Timer modules (see table below) | 86.30 | | 86.00, 86.30 | |
| Sheet of marker tags for retaining and release clip 094.91.3, plastic, 48 tags, 6 x 12 mm, for CEMBRE thermal transfer printers | 060.48 | | — | |
| Technical data | | | | |
| Rated values | 12 A - 250 V | | | |
| Dielectric strength | 2 kV AC | | | |
| Protection category | IP 20 | | | |
| Ambient temperature | °C -40...+70 (see diagram L96) | | | |
| ⊕ Screw torque | Nm | 0.8 | | |
| Wire strip length | mm | 8 | | |
| Max. wire size for 94.02/04 sockets | | solid wire | stranded wire | |
| | mm ² | 1 x 6 / 2 x 2.5 | 1 x 4 / 2 x 2.5 | |
| | AWG | 1 x 10 / 2 x 14 | 1 x 12 / 2 x 14 | |

L 96 - Rated current v ambient temperature

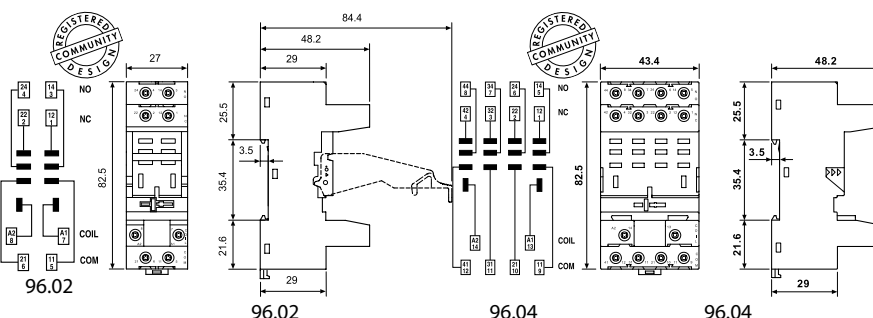
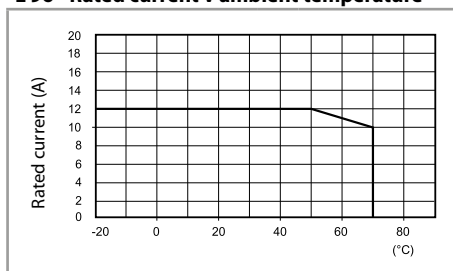

094.06



86.00



86.30



99.02

Approvals
(according to type):



DC Modules with non-standard polarity (+A2) on request.

| 6-way jumper link for 96.02 socket | 094.06 (blue) | 094.06.0 (black) |
|------------------------------------|---------------|------------------|
| Rated values | 10 A - 250 V | |

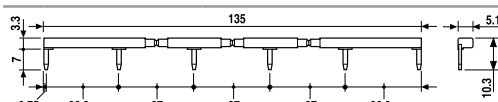

| 86 series timer modules | | |
|--|--|------------------|
| Multi-voltage: (12...240)V AC/DC; | | |
| Multi-functions: AI, DI, SW, BE, CE, DE, EE, FE; (0.05 s... 100 h) | | 86.00.0.240.0000 |
| (12...24)V AC/DC; Bi-function: AI, DI; (0.05 s... 100 h) | | 86.30.0.024.0000 |
| (110...125)V AC; Bi-function: AI, DI; (0.05 s... 100 h) | | 86.30.8.120.0000 |
| (230...240)V AC; Bi-function: AI, DI; (0.05 s... 100 h) | | 86.30.8.240.0000 |

Approvals (according to type): **CE EAC cRU US**

| 99.02 coil indication and EMC suppression modules for 96.02 and 96.04 sockets | | |
|--|--------------------|----------------|
| Diode (+A1, standard polarity) | (6...220)V DC | 99.02.3.000.00 |
| LED | (6...24)V DC/AC | 99.02.0.024.59 |
| LED | (28...60)V DC/AC | 99.02.0.060.59 |
| LED | (110...240)V DC/AC | 99.02.0.230.59 |
| LED + Diode (+A1, standard polarity) | (6...24)V DC | 99.02.9.024.99 |
| LED + Diode (+A1, standard polarity) | (28...60)V DC | 99.02.9.060.99 |
| LED + Diode (+A1, standard polarity) | (110...220)V DC | 99.02.9.220.99 |
| LED + Varistor | (6...24)V DC/AC | 99.02.0.024.98 |
| LED + Varistor | (28...60)V DC/AC | 99.02.0.060.98 |
| LED + Varistor | (110...240)V DC/AC | 99.02.0.230.98 |
| RC circuit | (6...24)V DC/AC | 99.02.0.024.09 |
| RC circuit | (28...60)V DC/AC | 99.02.0.060.09 |
| RC circuit | (110...240)V DC/AC | 99.02.0.230.09 |
| Residual current by-pass | (110...240)V AC | 99.02.8.230.07 |

A

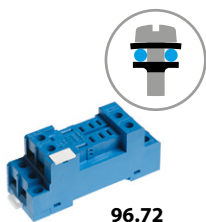

96.72

Approvals
(according to type):



96.74

Approvals
(according to type):



| | | | | |
|--|-----------------------------|--------------------------------|-----------------------------|--------------------------------|
| Screw terminal (Plate clamp) socket panel or 35 mm rail (EN 60715) mount | 96.72 Blue | 96.72.0 Black | 96.74 Blue | 96.74.0 Black |
| For relay type | 56.32 | | 56.34 | |
| Accessories | | | | |
| Metal retaining clip (supplied with socket - packaging code SMA) | 094.71 | | 096.71 | |
| Modules (see table below) | 99.01 | | | |
| Technical data | | | | |
| Rated values | 12 A - 250 V | | | |
| Dielectric strength | 2 kV AC | | | |
| Protection category | IP 20 | | | |
| Ambient temperature | °C | -40...+70 | | |
| Screw torque | Nm | 0.8 | | |
| Wire strip length | mm | 10 | | |
| Max. wire size for 96.72 and 96.74 sockets | | solid wire | stranded wire | |
| | mm ² | 1 x 4 / 2 x 4 | 1 x 4 / 2 x 2.5 | |
| | AWG | 1 x 12 / 2 x 12 | 1 x 12 / 2 x 14 | |

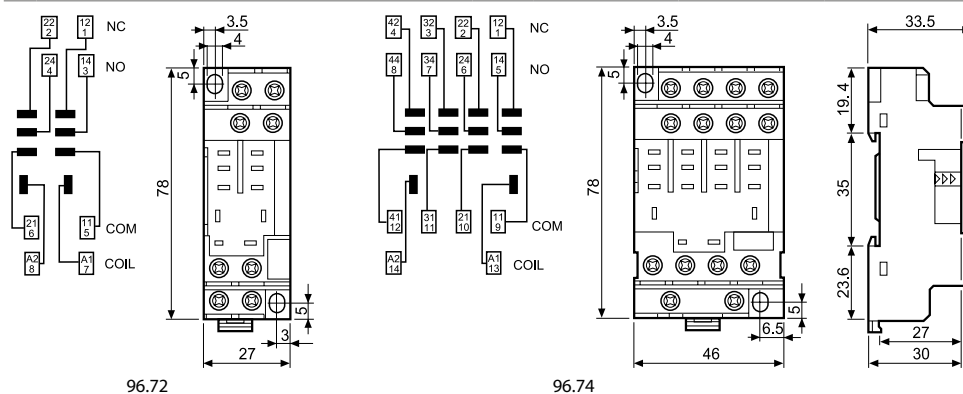

99.01

Approvals
(according to type):



* Modules in Black housing are available on request.
Green LED is standard.
Red LED available on request.

| 99.01 coil indication and EMC suppression modules for types 96.72 and 96.74 sockets | | Blue* |
|---|--------------------|----------------|
| Diode (+A1, standard polarity) | (6...220)V DC | 99.01.3.000.00 |
| Diode (+A2, non-standard polarity) | (6...220)V DC | 99.01.2.000.00 |
| LED | (6...24)V DC/AC | 99.01.0.024.59 |
| LED | (28...60)V DC/AC | 99.01.0.060.59 |
| LED | (110...240)V DC/AC | 99.01.0.230.59 |
| LED + Diode (+A1, standard polarity) | (6...24)V DC | 99.01.9.024.99 |
| LED + Diode (+A1, standard polarity) | (28...60)V DC | 99.01.9.060.99 |
| LED + Diode (+A1, standard polarity) | (110...220)V DC | 99.01.9.220.99 |
| LED + Diode (+A2, non-standard polarity) | (6...24)V DC | 99.01.9.024.79 |
| LED + Diode (+A2, non-standard polarity) | (28...60)V DC | 99.01.9.060.79 |
| LED + Diode (+A2, non-standard polarity) | (110...220)V DC | 99.01.9.220.79 |
| LED + Varistor | (6...24)V DC/AC | 99.01.0.024.98 |
| LED + Varistor | (28...60)V DC/AC | 99.01.0.060.98 |
| LED + Varistor | (110...240)V DC/AC | 99.01.0.230.98 |
| RC circuit | (6...24)V DC/AC | 99.01.0.024.09 |
| RC circuit | (28...60)V DC/AC | 99.01.0.060.09 |
| RC circuit | (110...240)V DC/AC | 99.01.0.230.09 |
| Residual current by-pass | (110...240)V AC | 99.01.8.230.07 |



96.12

A

Approvals
(according to type):



| PCB socket | 96.12 (blue) | 96.12.0 (blue) | 96.14 (blue) | 96.14.0 (blue) |
|-----------------------|-----------------|-------------------|-----------------|-------------------|
| For relay type | 56.32 | | 56.34 | |
| Accessories | 094.51 | | | |
| Technical data | | | | |
| Rated values | 15 A - 250 V | | | |
| Dielectric strength | 2 kV AC | | | |
| Protection category | IP 20 | | | |
| Ambient temperature | °C -40...+70 | | | |

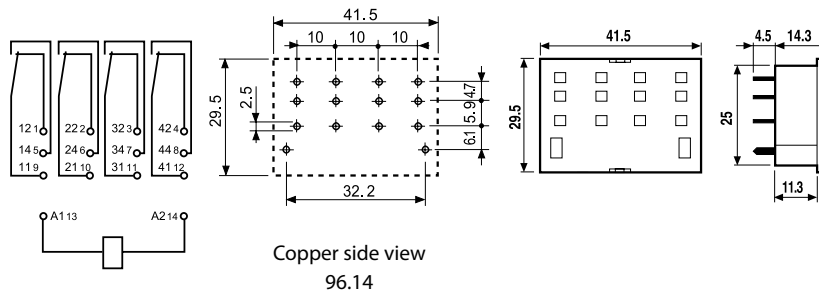
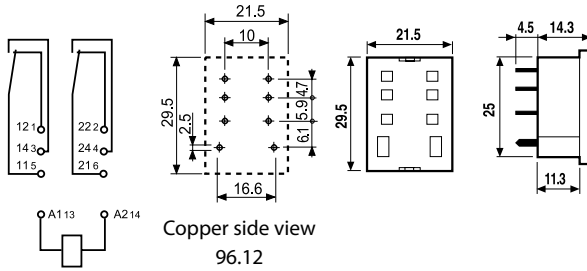

Packaging codes

How to code and identify retaining clip and packaging options for sockets.

Example:

